

Service Manual

Pioneer

RENAULT

SCU-2456ZRN/X1B/EW

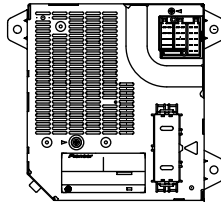

**ORDER NO.
CRT2457**

SYSTEM CONTROL UNIT

SCU-2456ZRN X1B/EW

SCU-2556ZRN X1B/EW

VEHICLE	DESTINATION	PRODUCED AFTER	PART No.	ID No.	PIONEER MODEL No.
ESPACE and AVANTIME	EUROPE	March 2000	6025 40 3834	—	SCU-2456ZRN/X1B/EW
ESPACE and AVANTIME	EUROPE	March 2000	6025 40 2759	—	SCU-2556ZRN/X1B/EW

CONTENTS

1. SAFETY INFORMATION	2	7. GENERAL INFORMATION	36
2. EXPLODED VIEWS AND PARTS LIST	2	7.1 CONNECTOR FUNCTION DESCRIPTION	36
3. BLOCK DIAGRAM AND SCHEMATIC DIAGRAM	9	7.2 IC	38
4. PCB CONNECTION DIAGRAM	18	7.3 OPERATIONAL FLOW CHART	40
5. ELECTRICAL PARTS LIST	24	8. SPECIFICATIONS.....	41
6. ADJUSTMENT.....	34		

PIONEER CORPORATION 4-1, Meguro 1-Chome, Meguro-ku, Tokyo 153-8654, Japan
PIONEER ELECTRONICS SERVICE INC. P.O.Box 1760, Long Beach, CA 90801-1760 U.S.A.
PIONEER EUROPE N.V. Haven 1087 Keetberglaan 1, 9120 Melsele, Belgium
PIONEER ELECTRONICS ASIACENTRE PTE.LTD. 253 Alexandra Road, #04-01, Singapore 159936

1. SAFETY INFORMATION

This service manual is intended for qualified service technicians; it is not meant for the casual do-it-yourselfer. Qualified technicians have the necessary test equipment and tools, and have been trained to properly and safely repair complex products such as those covered by this manual. Improperly performed repairs can adversely affect the safety and reliability of the product and may void the warranty. If you are not qualified to perform the repair of this product properly and safely, you should not risk trying to do so and refer the repair to a qualified service technician.

2. EXPLODED VIEWS AND PARTS LIST

2.1 PACKING

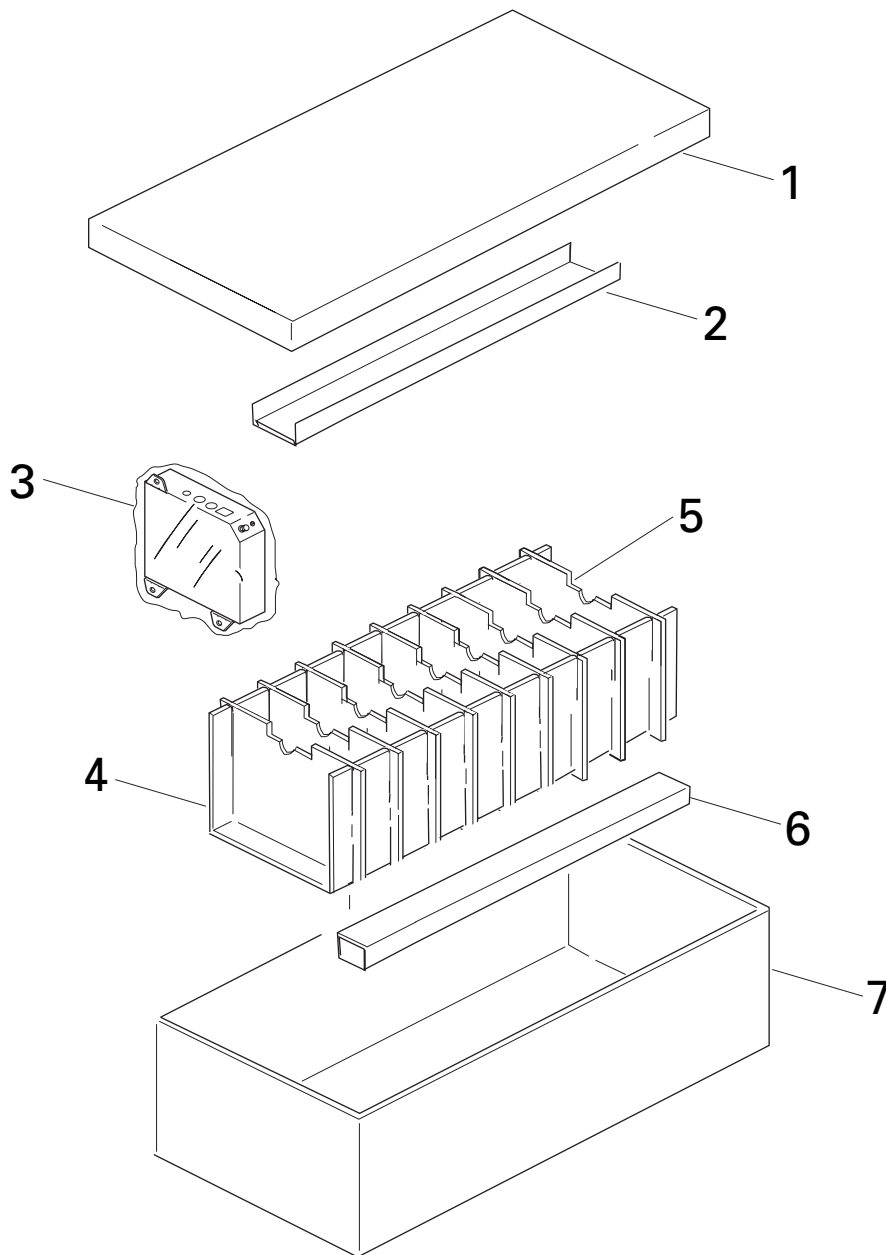

NOTE:

- Parts marked by "*" are generally unavailable because they are not in our Master Spare Parts List.
- Screws adjacent to ∇ mark on the product are used for disassembly.

● PACKING SECTION PARTS LIST

Mark No.	Description	Part No.
1	Cover	UHD-026
2	Protector	UHP-020
3	Polyethylene Bag	UEG-012
4	Protector	UHP-018
5	Protector	UHP-019
6	Protector	UHP2266
7	Contain Box(2456ZRN)	UHL3974
	Contain Box(2556ZRN)	UHL3975

2.2 EXTERIOR(SCU-2456ZRN)

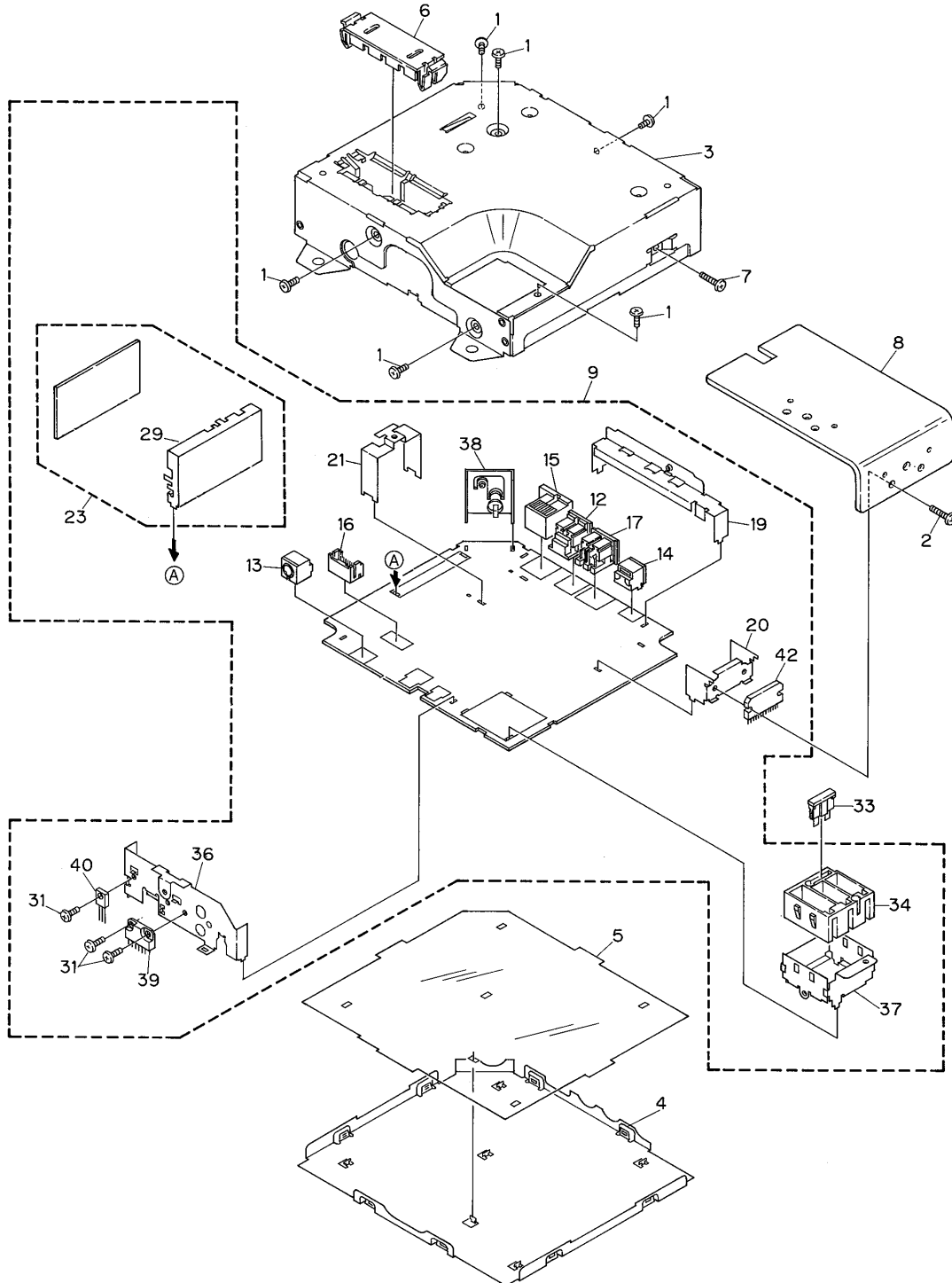

● EXTERIOR SECTION PARTS LIST

Mark No.	Description	Part No.
1	Screw	BMZ30P060FMC
2	Screw	BMZ30P140FMC
3	Chassis	CNA2288
4	Case	CNB1780
5	Insulator	CNM3864
6	Cover	CNS4018
7	Screw	BMZ30P140FMC
8	Heat Sink	CNC7755
9	Tuner Amp Unit	UWM6914
10,11	
12	Connector(CN652)	CKS3180
13	Connector(CN852)	CKS3181
14	Connector(CN701)	CKS3182
15	DIN Socket(CN651)	CKS3185
16	Connector(CN851)	CKS3186
17	DIN Socket(CN653)	CKS3189
18	
19	Holder	CNC5105
20	Holder	CNC5107
21	Holder	CNC5433
22	
23	FM/AM Tuner Unit	CWE1416
24-28	
29	Holder	CNC6555
30	
31	Screw	BMZ30P060FMC
32	
33	Fuse(10A)	CEK1136
34	Connector(CN551)	CKM1258
35	
36	Holder	CNC5106
37	Holder	CNC5435
38	Holder Unit(CN501)	CXA6151
39	IC(IC901)	PA2024A
40	Transistor(Q906)	2SA1358
41	
42	IC(IC551)	TDA7385

2.3 EXTERIOR(SCU-2556ZRN)

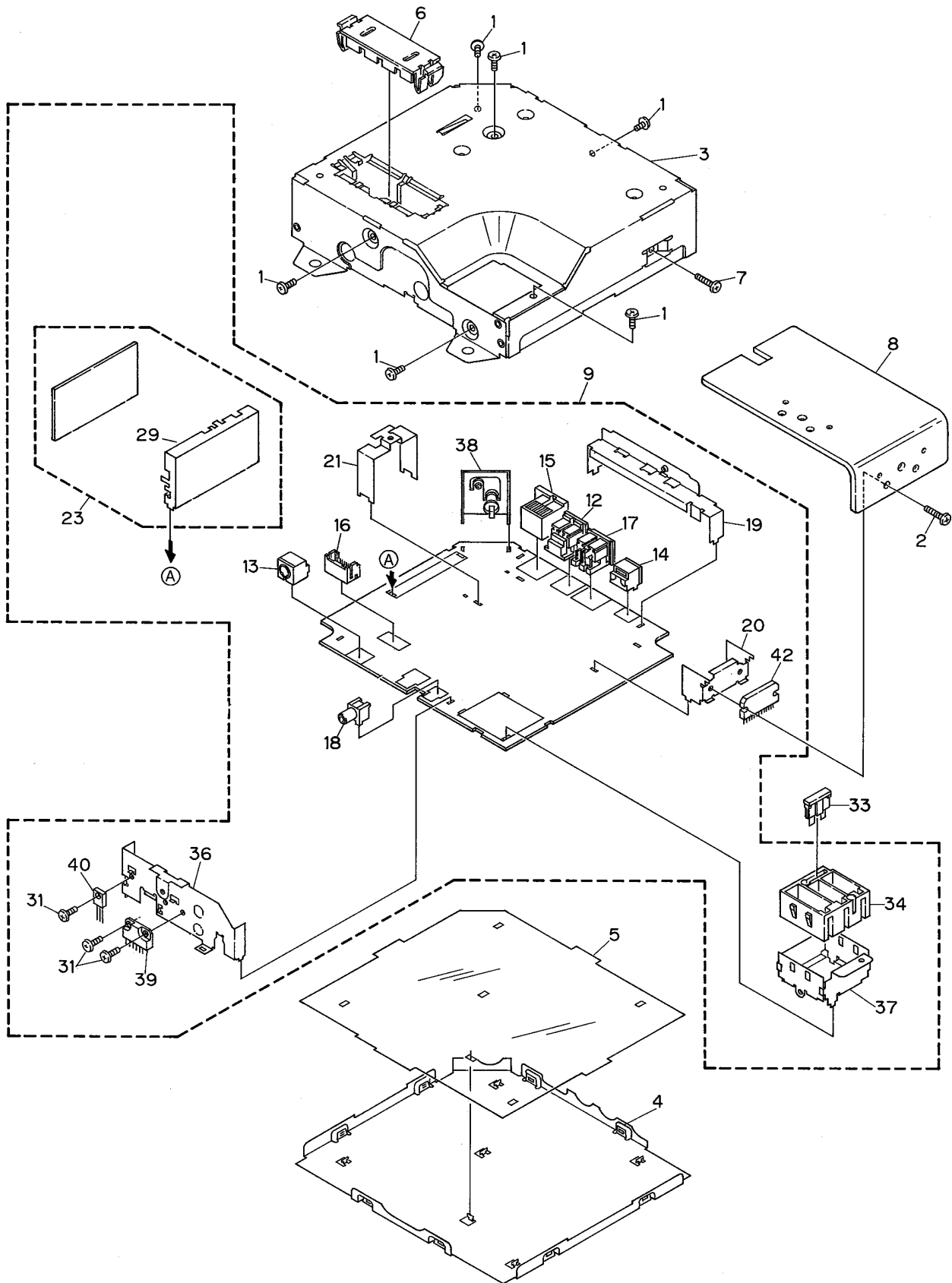

● EXTERIOR SECTION PARTS LIST

Mark No.	Description	Part No.
1	Screw	BMZ30P060FMC
2	Screw	BMZ30P140FMC
3	Chassis	CNA2289
4	Case	CNB1780
5	Insulator	CNM3864
6	Cover	CNS4018
7	Screw	BMZ30P140FMC
8	Heat Sink	CNC7755
9	Tuner Amp Unit	UWM6917
10,11	
12	Connector(CN652)	CKS3180
13	Connector(CN852)	CKS3181
14	Connector(CN701)	CKS3182
15	DIN Socket(CN651)	CKS3185
16	Connector(CN851)	CKS3186
17	DIN Socket(CN653)	CKS3189
18	Pin Jack(CN401)	CKS3200
19	Holder	CNC5105
20	Holder	CNC5107
21	Holder	CNC5433
22	
23	FM/AM Tuner Unit	CWE1416
24-28	
29	Holder	CNC6555
30	
31	Screw	BMZ30P060FMC
32	
33	Fuse(10A)	CEK1136
34	Connector(CN551)	CKM1258
35	
36	Holder	CNC5106
37	Holder	CNC5435
38	Holder Unit(CN501)	CXA6151
39	IC(IC901)	PA2024A
40	Transistor(Q906)	2SA1358
41	
42	IC(IC551)	PAL003A

SCU-2456ZRN,2556ZRN

3. BLOCK DIAGRAM AND SCHEMATIC DIAGRAM

3.1 BLOCK DIAGRAM

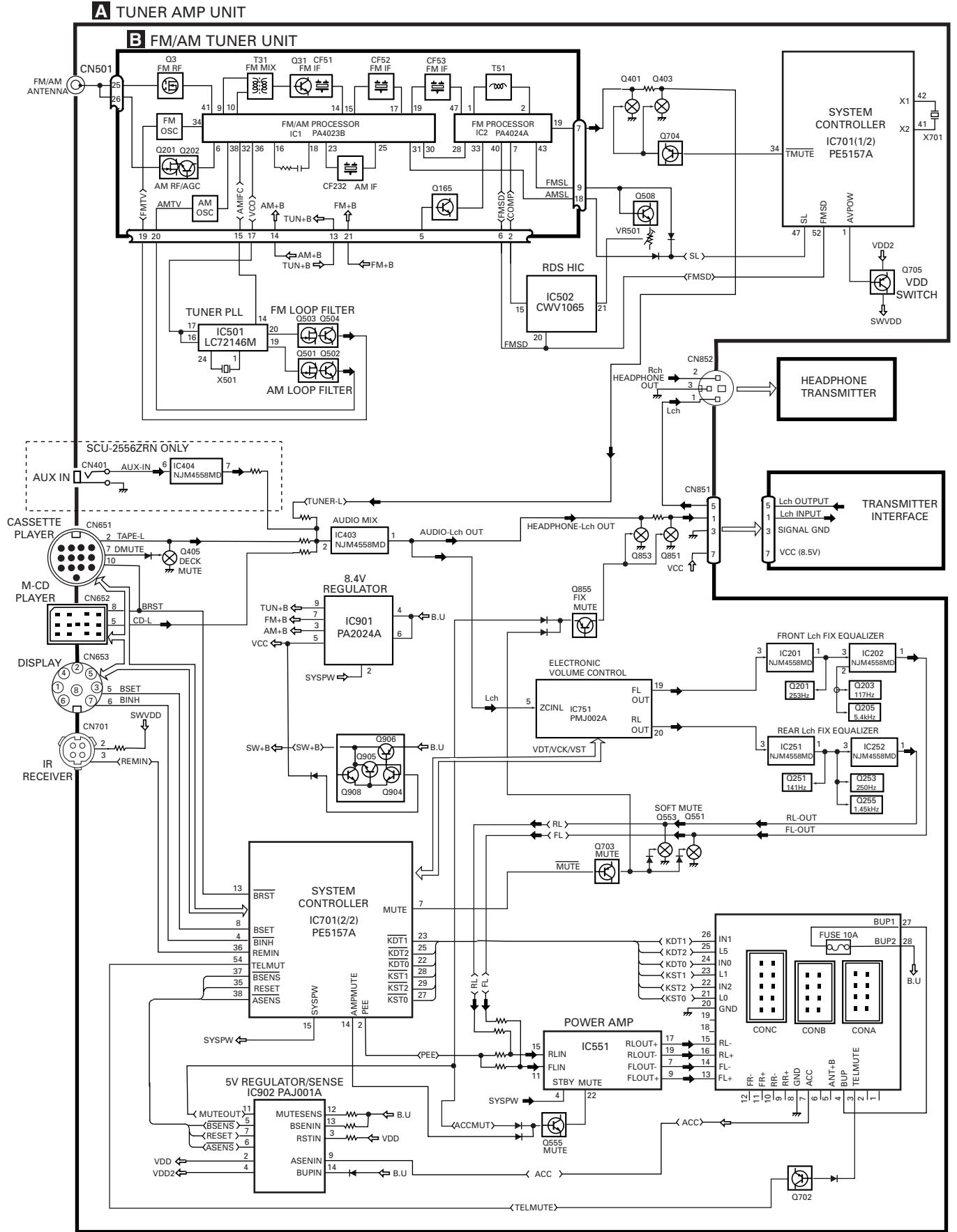

3.2 OVERALL CONNECTION DIAGRAM(GUIDE PAGE)

Note: When ordering service parts, be sure to refer to "EXPLODED VIEWS AND PARTS LIST" or "ELECTRICAL PARTS LIST".

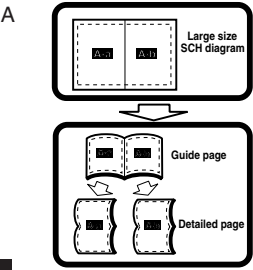

A-a

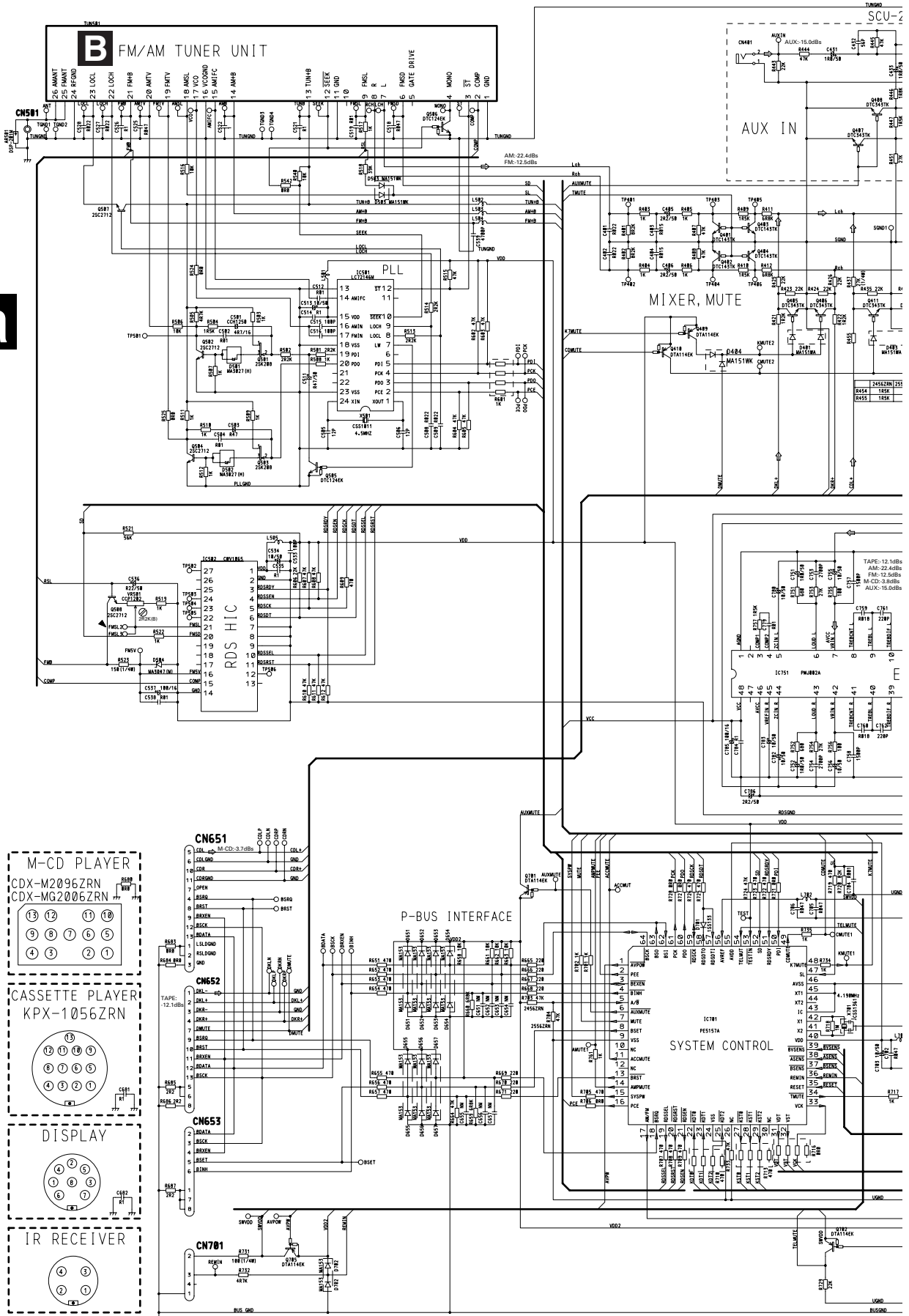

A-b

2556ZRN ONLY

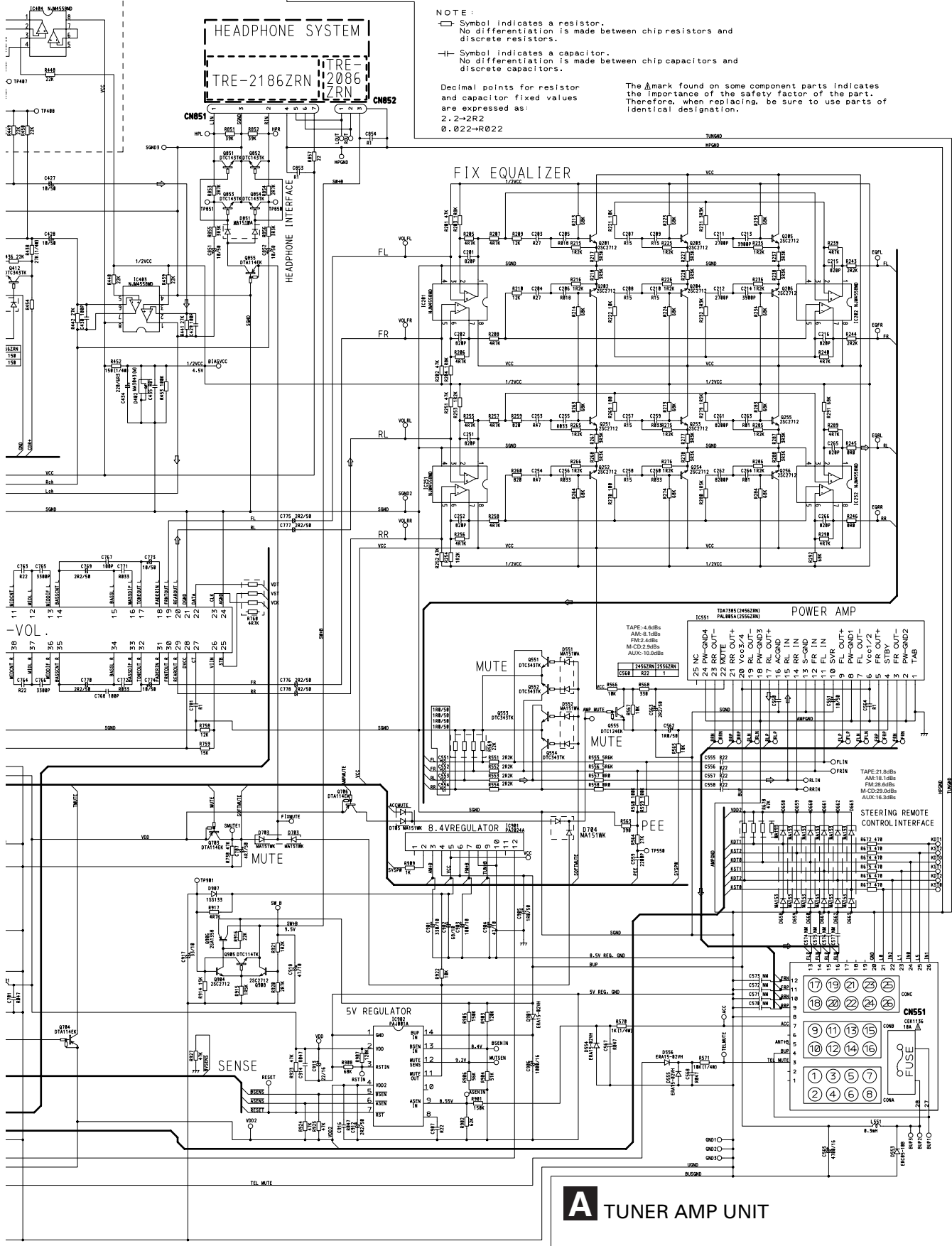

A TUNER AMP UNIT



A-a A-b

A

B

C

D

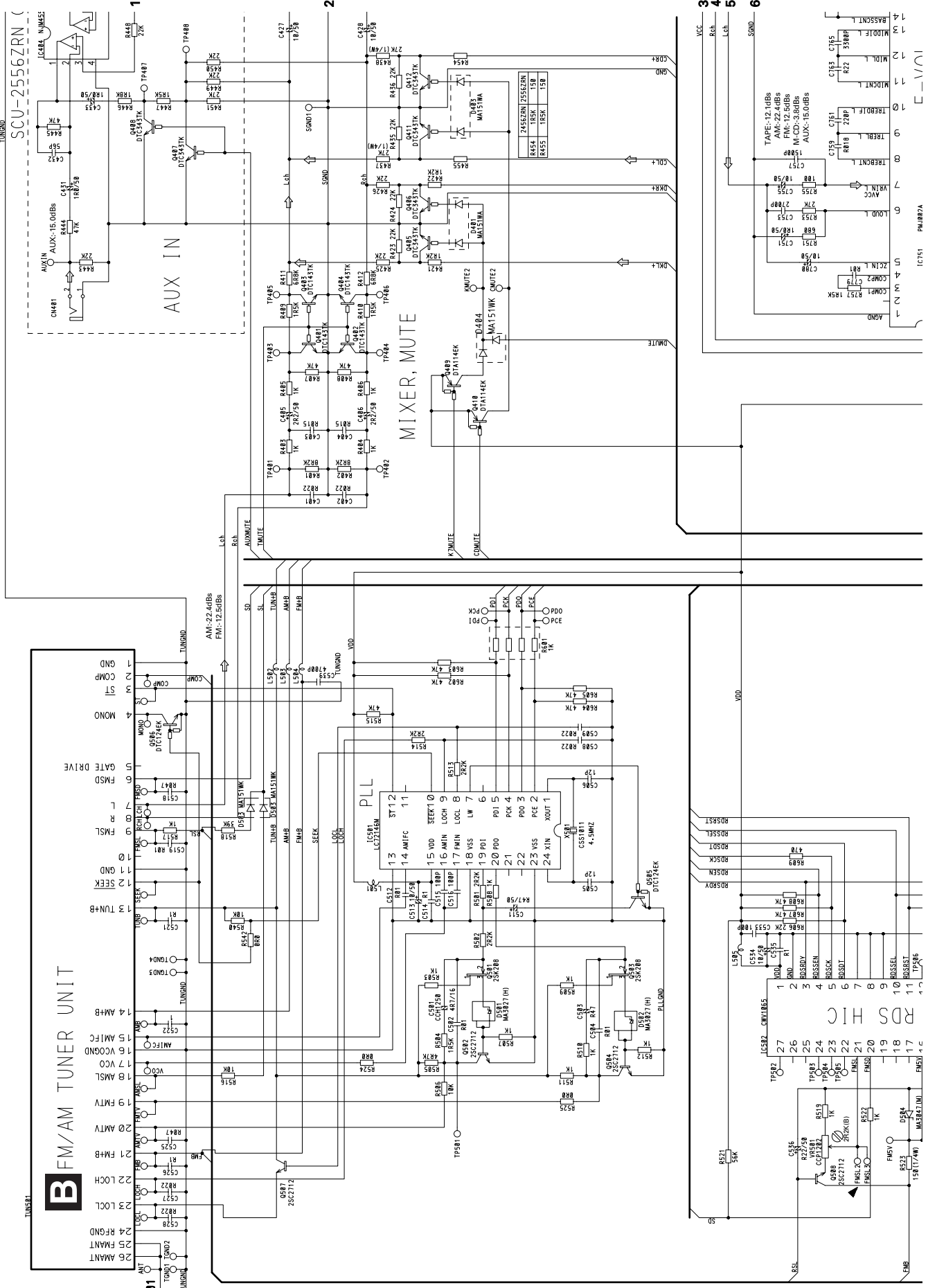

2

3

4

2

3

4

D

C

B

A

IC151 PA18R7A

RDS HIC

1 2 3 4 5 6 7 8 9 10 11 12 13 14

AMPN 1 2 3 4 5 6 7 8 9 10 11 12 13 14

1 2 3 4 5 6 7 8 9 10 11 12 13 14

1 2 3 4 5 6 7 8 9 10 11 12 13 14

1 2 3 4 5 6 7 8 9 10 11 12 13 14

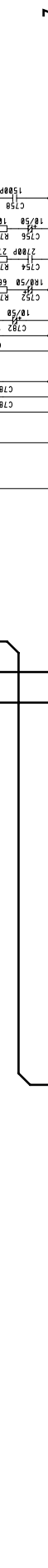
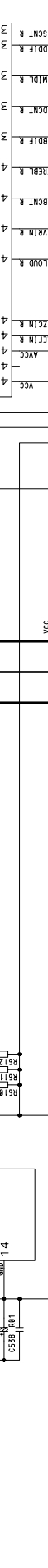
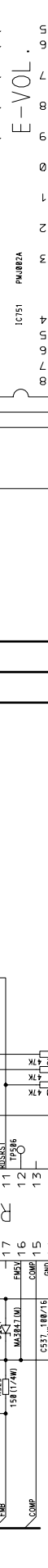
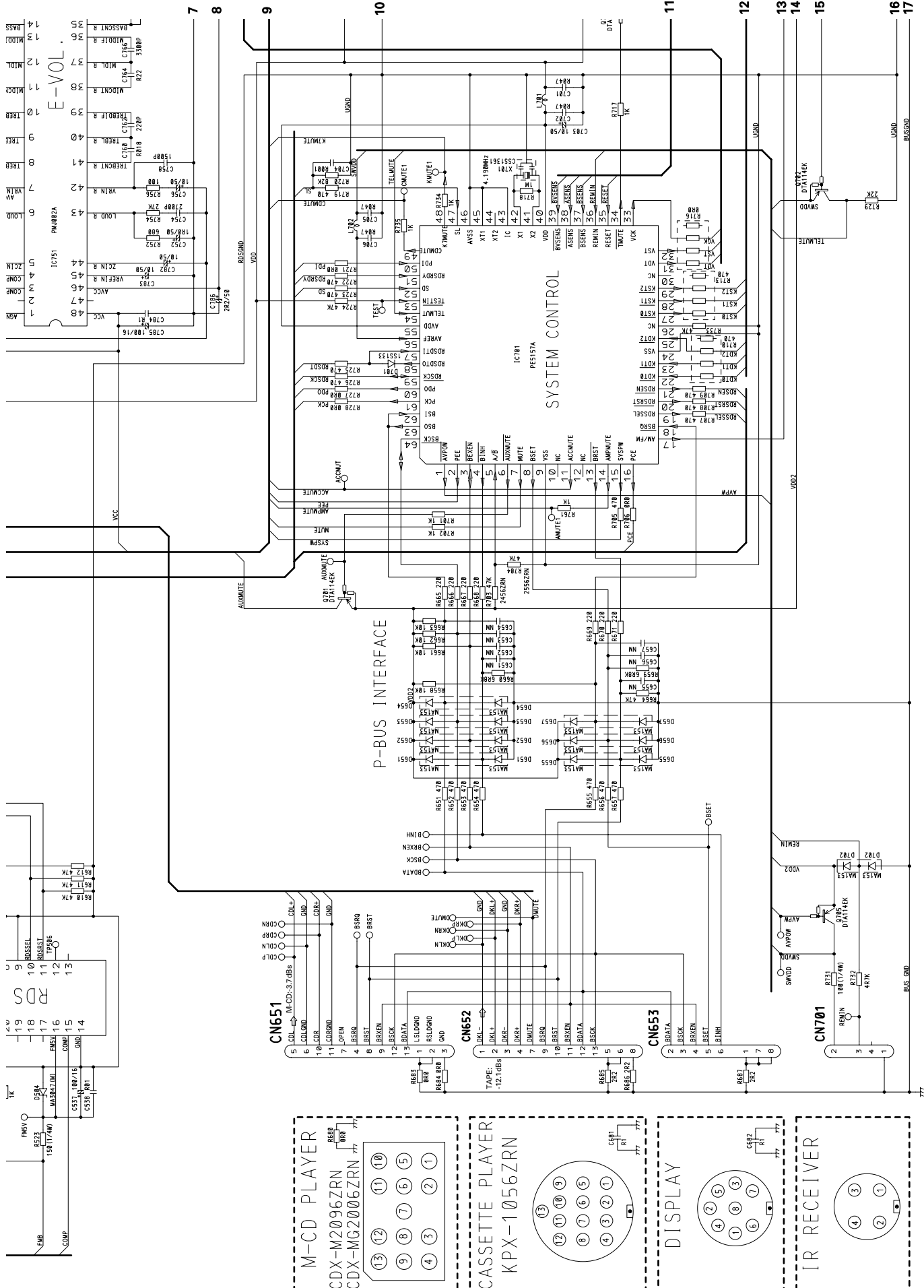

A-a A-b

A

B

C

D

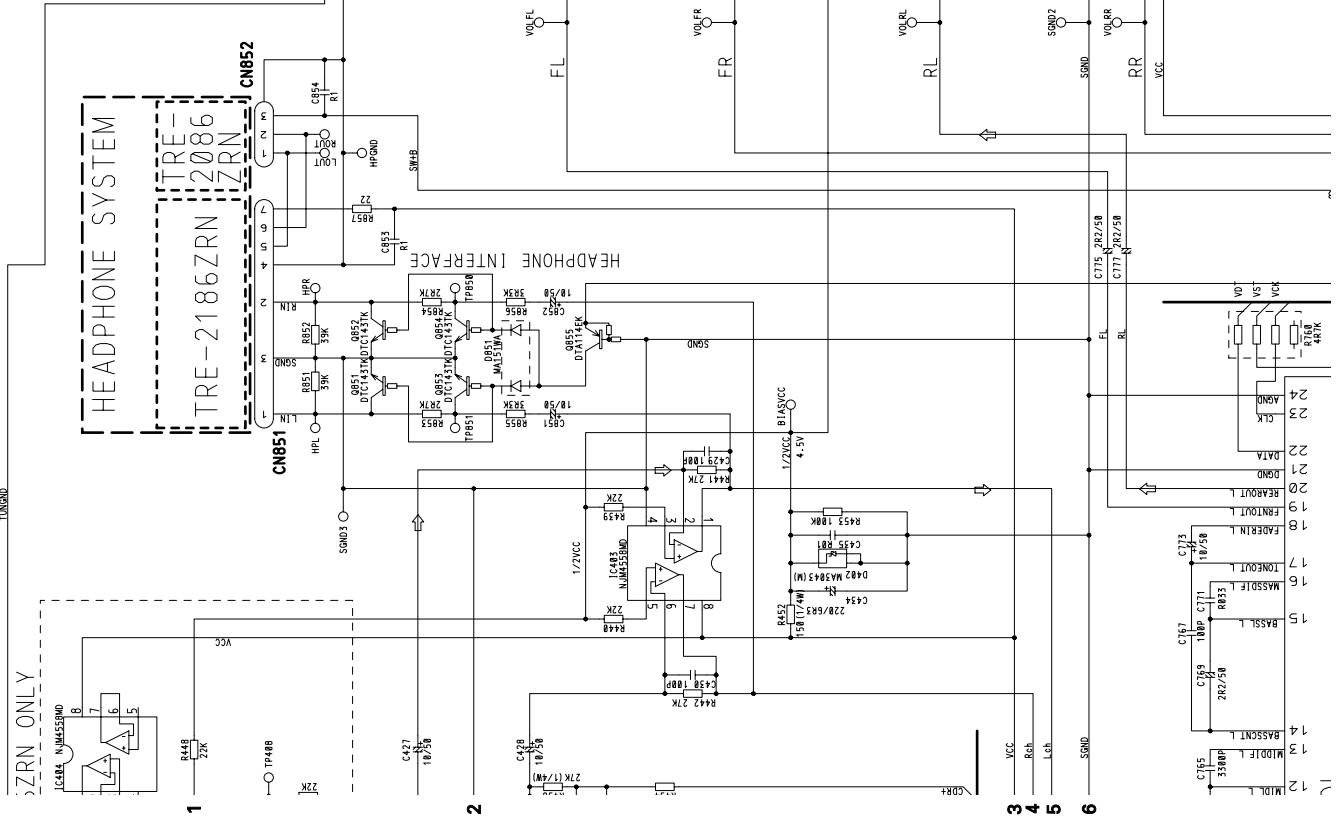

NOTE:

- Symbol indicates a resistor. No differentiation is made between chip resistors and discrete resistors.
- Symbol indicates a capacitor. No differentiation is made between chip capacitors and discrete capacitors.

The Δ mark found on some component parts indicates the importance of the safety factor of the part. Therefore, when replacing, be sure to use parts of identical designation.

Decimal points for resistor and capacitor fixed values are expressed as:
 2.2→R22
 0.022→R022

FIX EQUALIZER

POWER AMP

TAPE:4.6dBs
 TD4785(2456ZRN)
 PAL854(2556ZRN)
 IC551

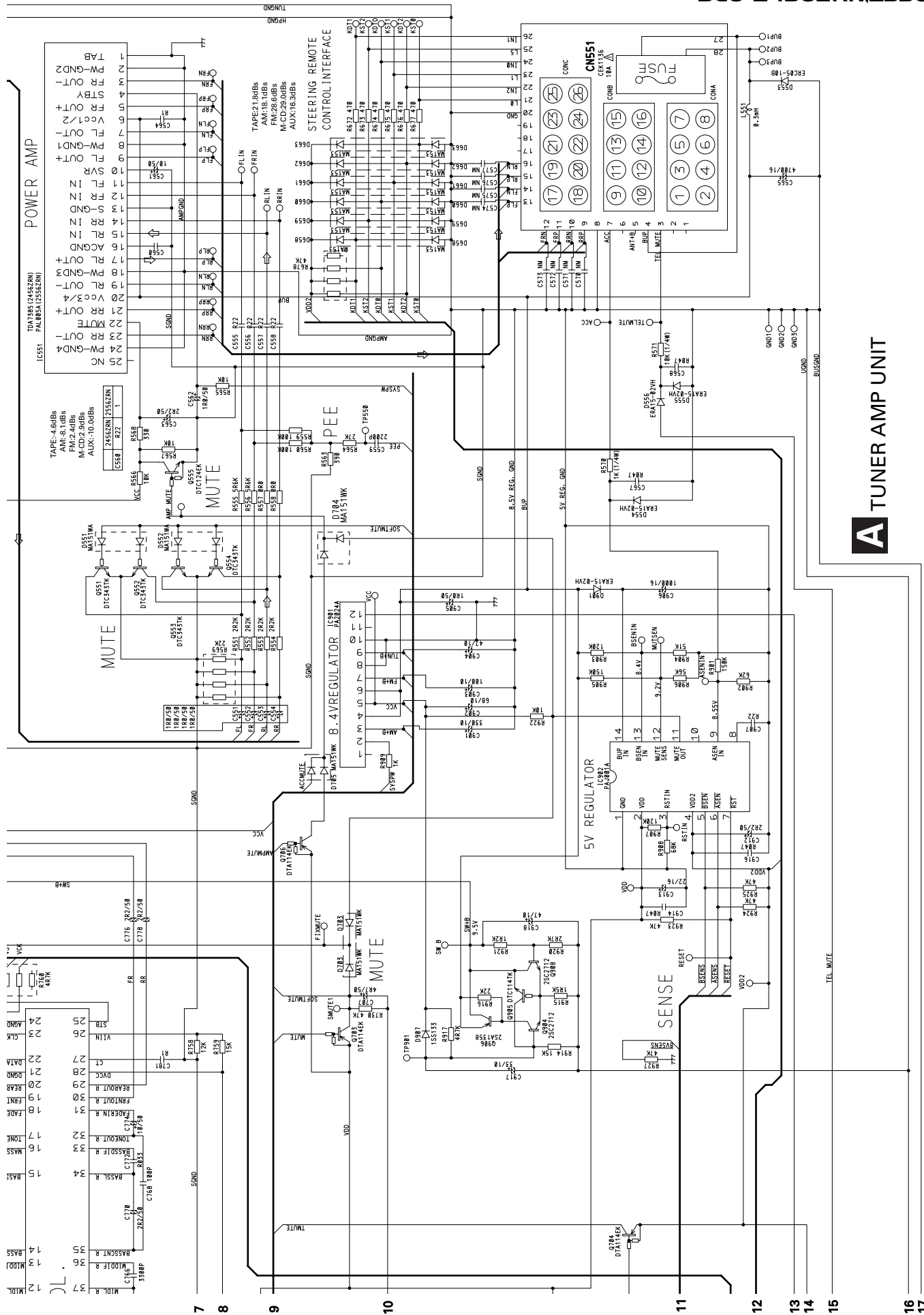

A TUNER AMP UNIT

A-a A-b

A-b

3.3 FM/AM TUNER UNIT

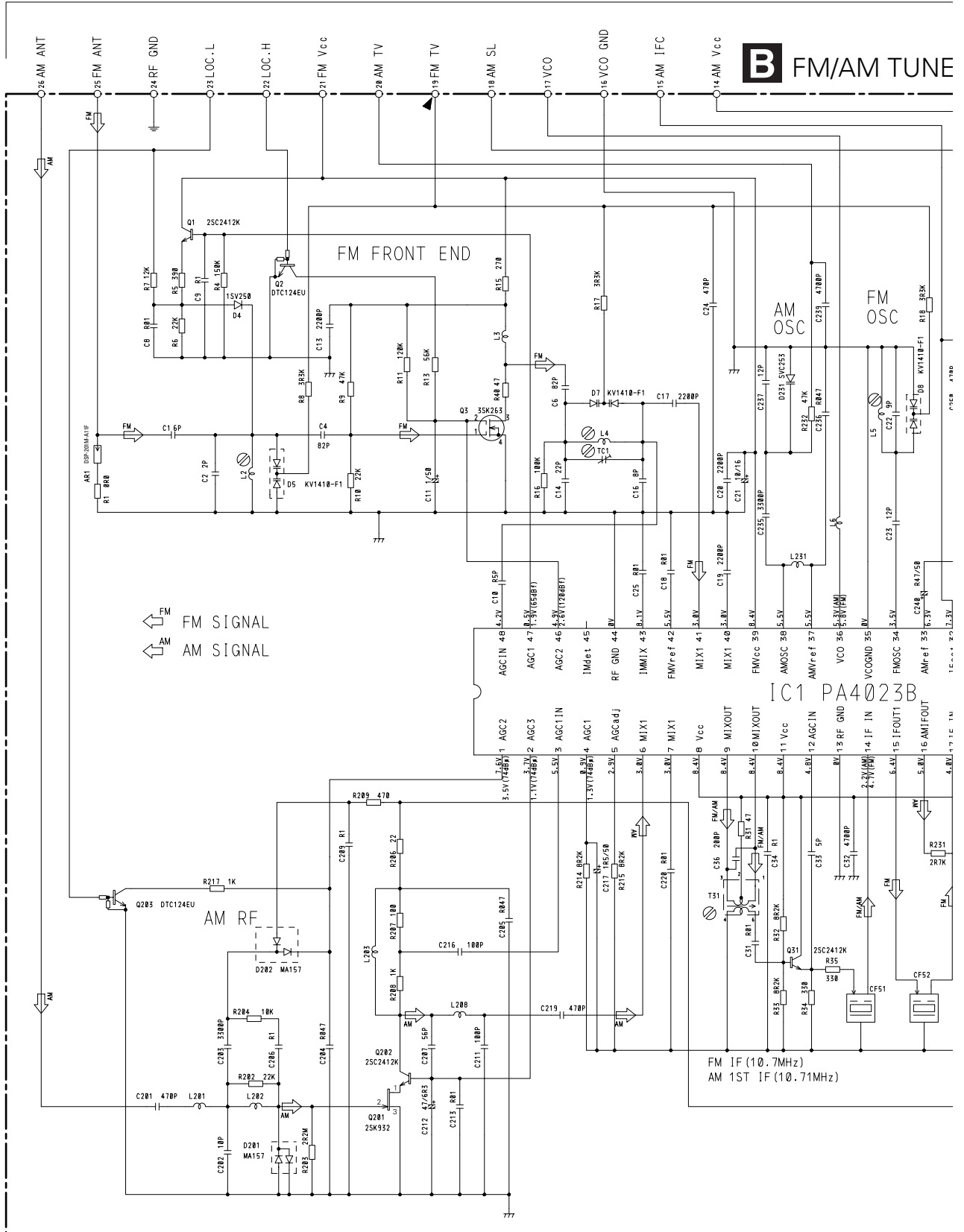

B FM/AM TUNE

IC1 PA4023B

UNDER UNIT

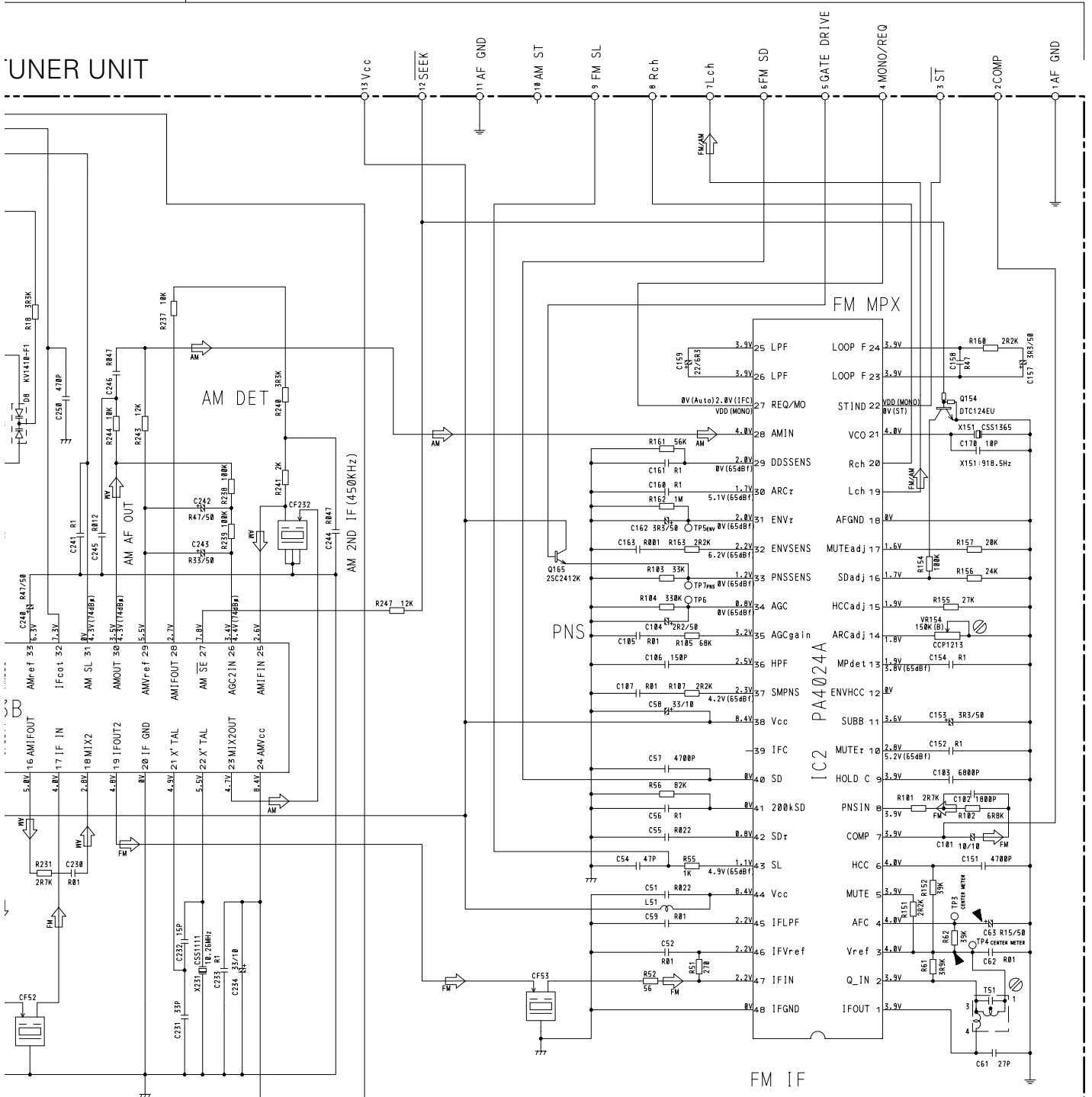

4. PCB CONNECTION DIAGRAM

4.1 TUNER AMP UNIT

A NOTE FOR PCB DIAGRAMS

- The parts mounted on this PCB include all necessary parts for several destination. For further information for respective destinations, be sure to check with the schematic diagram.
- Viewpoint of PCB diagrams

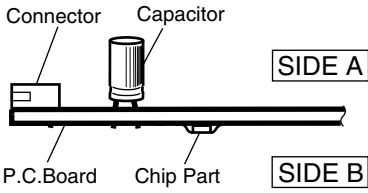

A TUNER AMP UNIT

IC, Q	ADJ
IC901	Q906
Q904	Q908
IC404	
IC403	
IC751	VR501
Q409	
Q410	Q909
IC902	
Q252	Q251 IC502
	Q254 Q253
	Q256 Q255
IC251	IC201
Q202	Q201
Q204	Q203
Q206	Q205
IC501	
IC551	
IC252	IC202
	IC701
Q504	
Q553	
Q551	Q505
	Q502
	Q554
Q705	
Q552	
Q555	

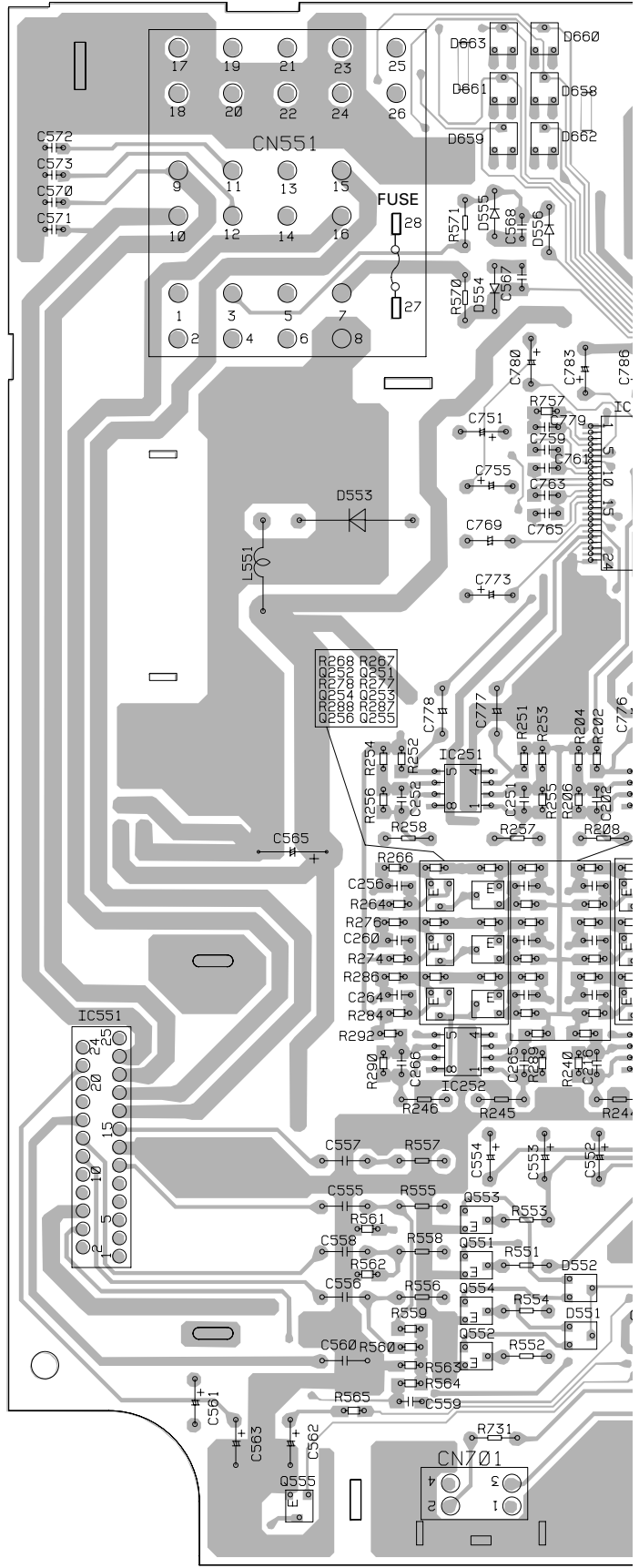

IR RECEIVER



HEADPHONE SYSTEM

SIDE A

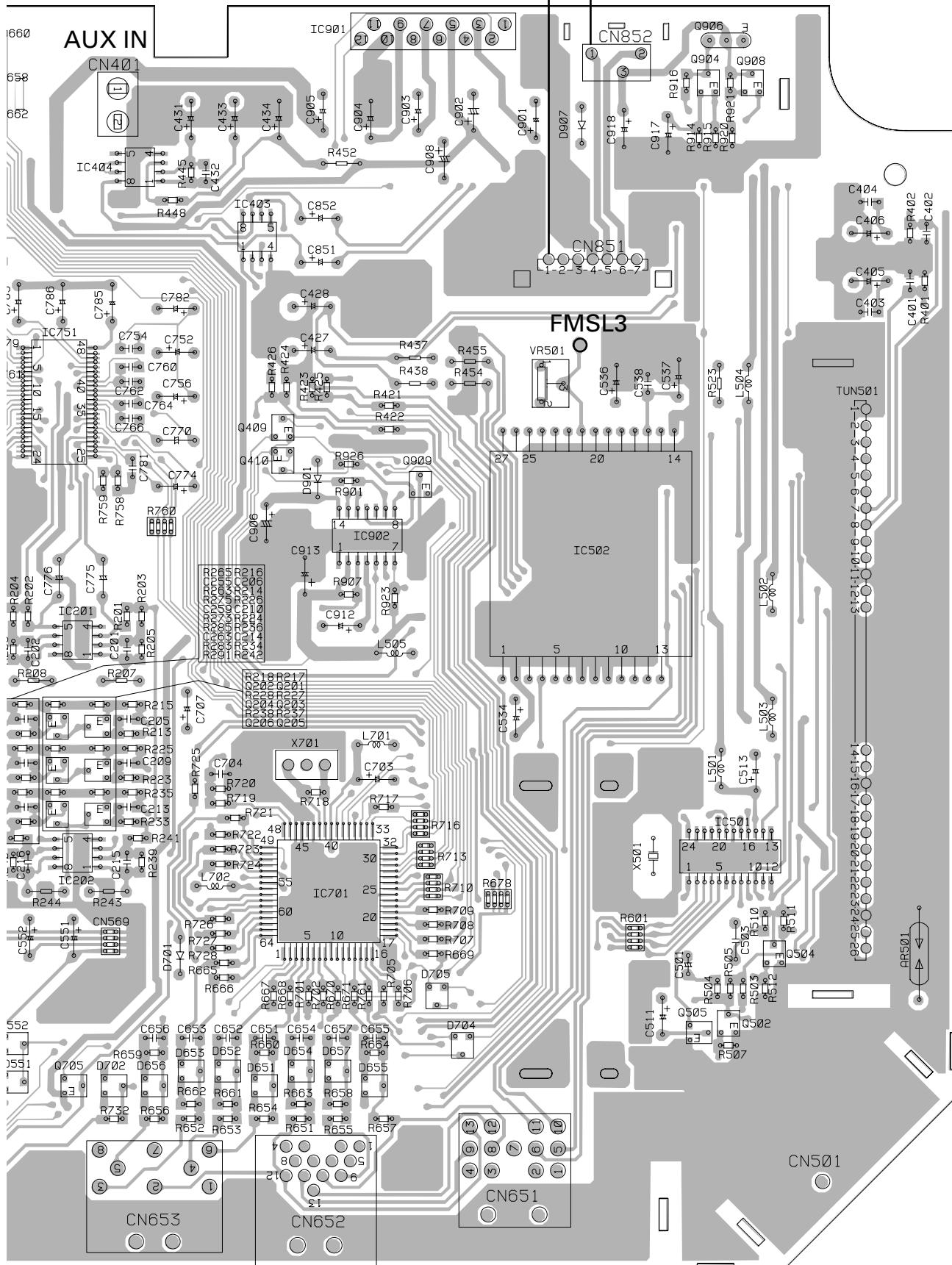

A
B
C
D

DISPLAY

CASSETTE
PLAYER

M-CD PLAYER



A TUNER AMP UNIT

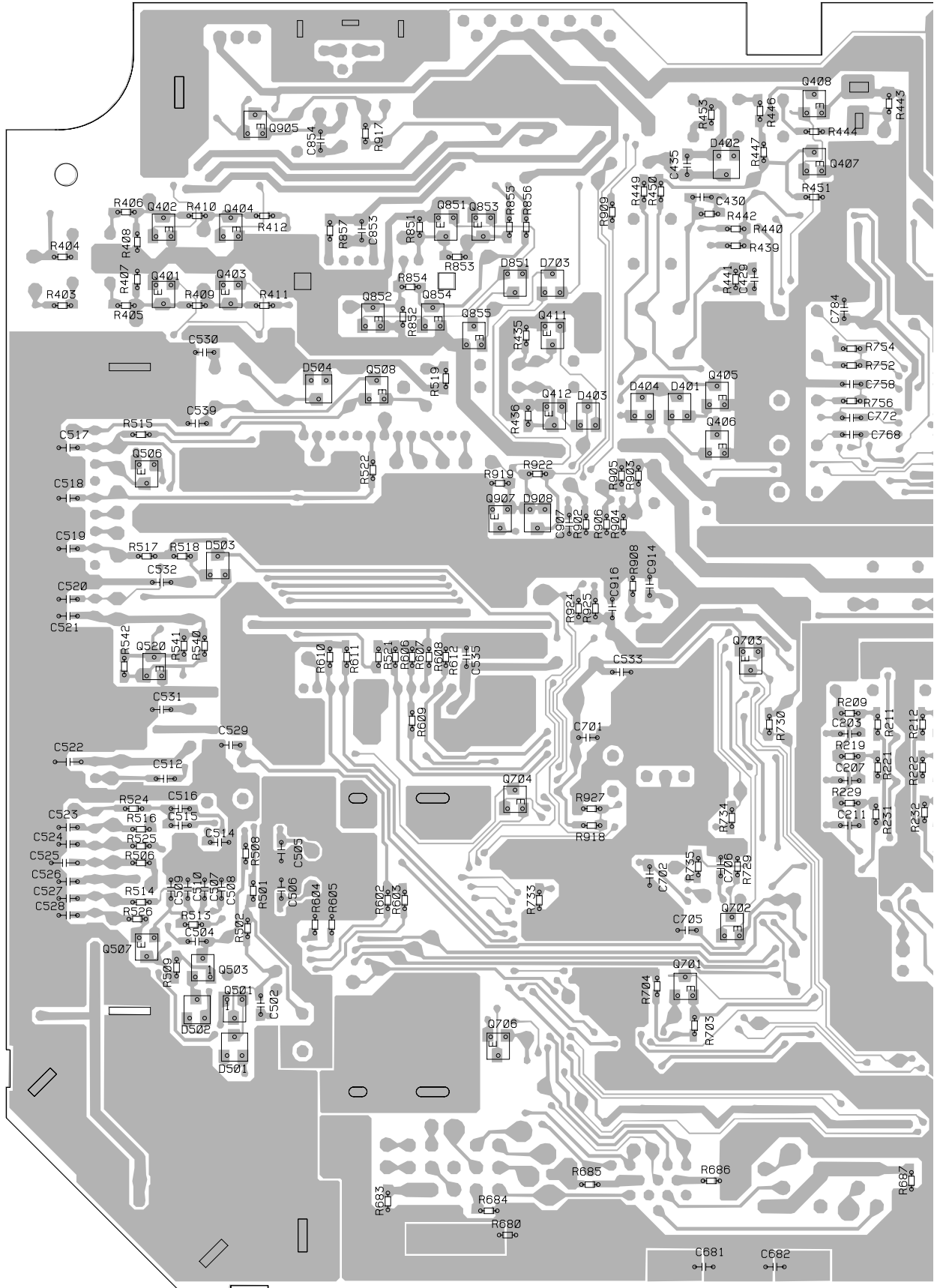

SIDE B

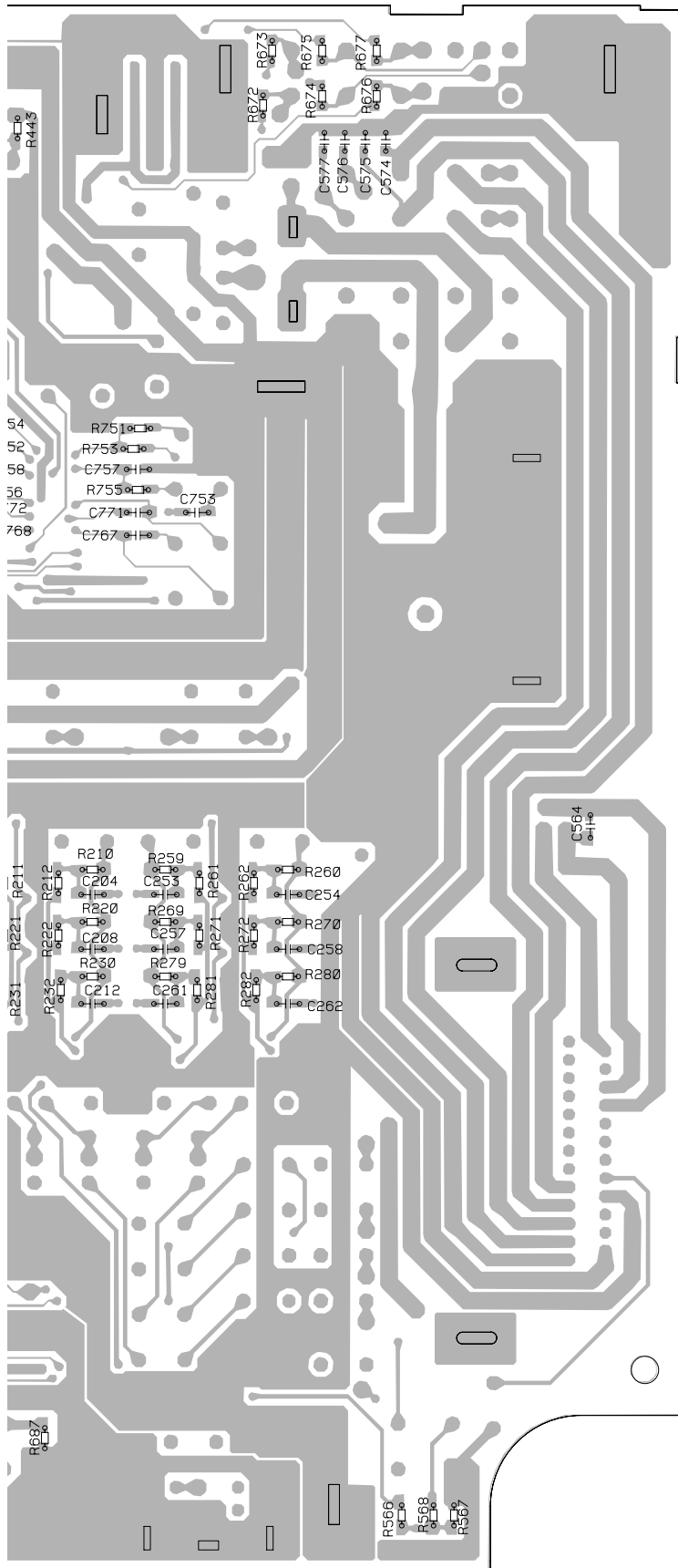

- IC, Q
- Q408
- Q905
- Q407
- Q402 Q404
- Q851 Q853
- Q401 Q403
- Q852 Q854
- Q855
- Q411
- Q508
- Q405
- Q412
- Q406
- Q506
- Q907
- Q703
- Q520
- Q704
- Q702
- Q507 Q503 Q701
- Q501
- Q706

A

B

C

D

4.2 FM/AM TUNER UNIT

SIDE A

B FM/AM TUNER UNIT

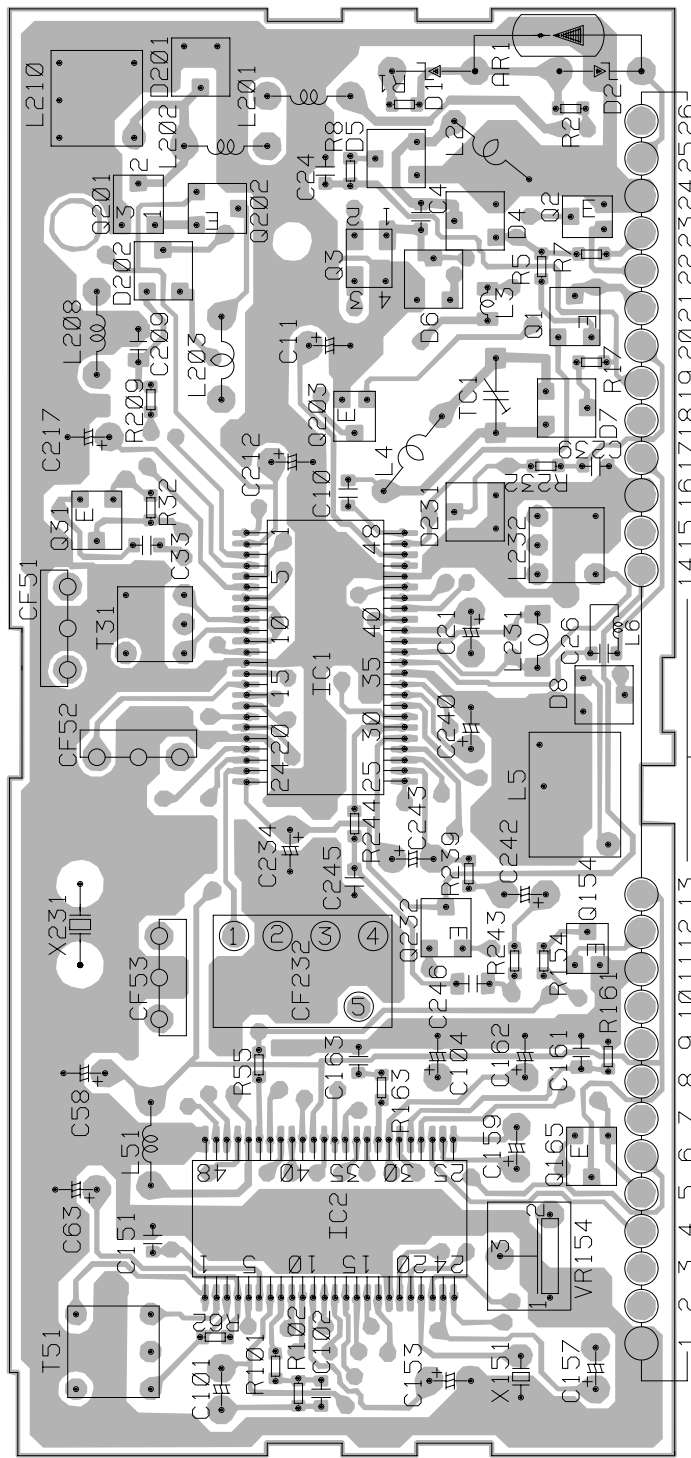

- | | |
|-------|-------|
| IC, Q | ADJ |
| Q31 | T51 |
| Q201 | T31 |
| Q202 | |
| Q203 | L4 |
| IC2 | L2 |
| IC1 | TC1 |
| Q232 | L5 |
| Q1 | VR154 |
| Q165 | |
| Q2 | |
| Q154 | |

SIDE B

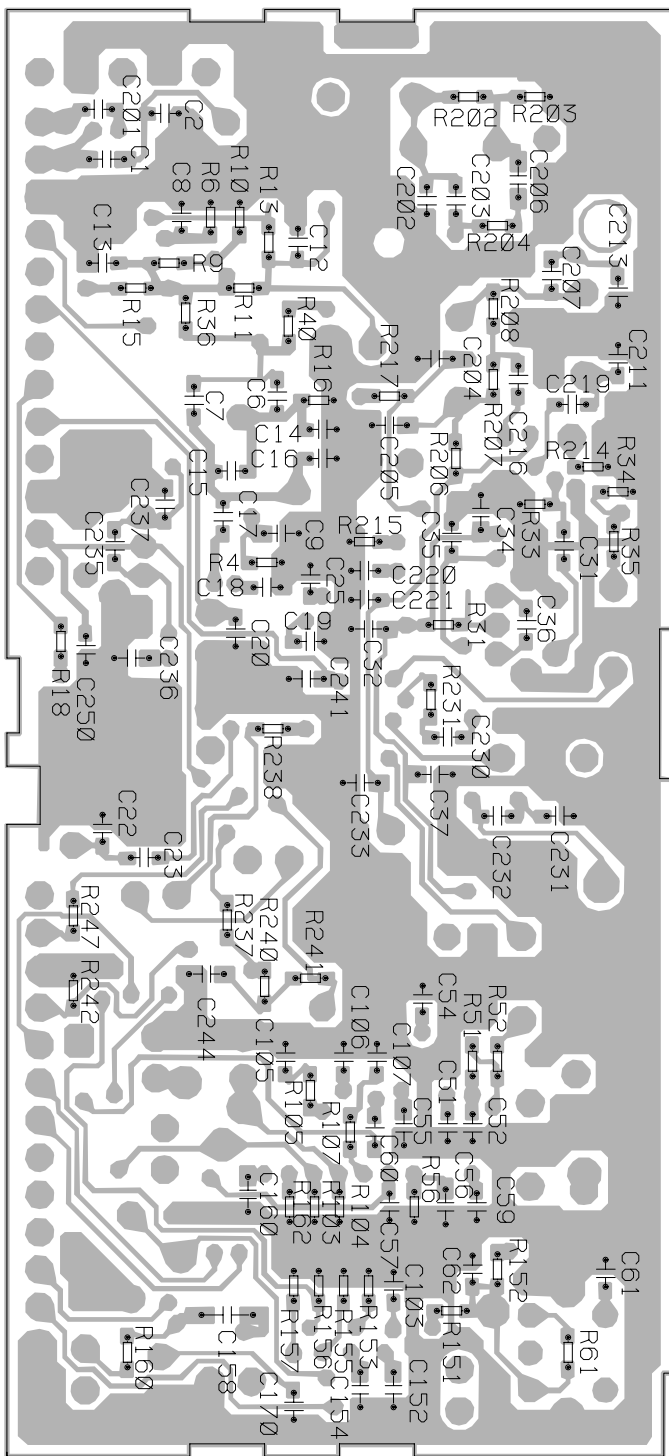

B FM/AM TUNER UNIT

5. ELECTRICAL PARTS LIST

NOTES:

- Parts whose parts numbers are omitted are subject to being not supplied.
- The part numbers shown below indicate chip components.

Chip Resistor

RS1/OSOOOJ,RS1/OOSOOOJ

Chip Capacitor (except for CQS.....)

CKS....., CCS....., CSZS.....

====Circuit Symbol and No.====Part Name	Part No.	====Circuit Symbol and No.====Part Name	Part No.
B Unit Number : CWE1416		R 15	RS1/16S271J
Unit Name : FM/AM Tuner Unit		R 16	RS1/16S104J
MISCELLANEOUS		R 17	RS1/16S332J
IC 1 IC	PA4023B	R 18	RS1/16S332J
IC 2 IC	PA4024A	R 31	RS1/16S470J
Q 1 Transistor	2SC2412K	R 32	RS1/16S822J
Q 2 Transistor	DTC124EU	R 33	RS1/16S822J
Q 3 FET	3SK263	R 34	RS1/16S331J
		R 35	RS1/16S331J
		R 40	RS1/16S470J
Q 31 Transistor	2SC2412K	R 51	RS1/16S271J
Q 154 Transistor	DTC124EU	R 52	RS1/16S560J
Q 165 Transistor	2SC2412K	R 55	RS1/16S102J
Q 201 FET	2SK932	R 56	RS1/16S823J
Q 202 Transistor	2SC2412K	R 61	RS1/16S392J
Q 203 Transistor	DTC124EU	R 62	RS1/16S393J
D 4 Diode	1SV250	R 101	RS1/16S272J
D 5 Diode	KV1410-F1	R 102	RS1/16S682J
D 7 Diode	KV1410-F1	R 103	RS1/16S333J
D 8 Diode	KV1410-F1	R 104	RS1/16S334J
D 201 Diode	MA157	R 105	RS1/16S683J
D 202 Diode	MA157	R 107	RS1/16S222J
D 231 Diode	SVC253	R 151	RS1/16S222J
L 2 Coil	CTC1108	R 152	RS1/16S393J
L 3 Inductor	LCTB2R2K2125	R 154	RS1/16S104J
L 4 Coil	CTC1108	R 155	RS1/16S273J
L 5 Coil	CTC1107	R 156	RS1/16S243J
L 6 Inductor	LCTBR15K1608	R 157	RS1/16S203J
L 51 Ferri-Inductor	LAU150K	R 160	RS1/16S222J
L 201 Ferri-Inductor	LAU4R7K	R 161	RS1/16S563J
L 202 Ferri-Inductor	LAU330K	R 162	RS1/16S105J
L 203 Inductor	CTF1287	R 163	RS1/16S222J
L 208 Inductor	LAU121K	R 202	RS1/16S223J
L 231 Inductor	LCTA3R3J3225	R 203	RS1/16S225J
T 31 Coil	CTE1116	R 204	RS1/16S103J
T 51 Coil	CTC1136	R 206	RS1/16S220J
TC 1 Capacitor	CCL1046	R 207	RS1/16S101J
CF 51 Ceramic Filter	CTF1442	R 208	RS1/16S102J
CF 52 Ceramic Filter	CTF1442	R 209	RS1/16S471J
CF 53 Ceramic Filter	CTF1442	R 214	RS1/16S822J
CF 232 Ceramic Filter	CTF1348	R 215	RS1/16S822J
X 151 Radiator 918.5Hz	CSS1365	R 217	RS1/16S102J
X 231 Crystal Resonator 10.26MHz	CSS1111	R 231	RS1/16S272J
VR 154 Semi-fixed 150kΩ(B)	CCP1213	R 232	RS1/16S473J
AR 1	DSP-201M	R 237	RS1/16S103J
RESISTORS		R 238	RS1/16S104J
		R 239	RS1/16S104J
R 1	RS1/16S0R0J	R 240	RS1/16S332J
R 4	RS1/16S154J	R 241	RS1/16S202J
R 5	RS1/16S391J	R 243	RS1/16S123J
R 6	RS1/16S223J		
R 7	RS1/16S123J	R 244	RS1/16S103J
		R 247	RS1/16S123J
R 8	RS1/16S332J		
R 9	RS1/16S473J		
R 10	RS1/16S223J		
R 11	RS1/16S124J		
R 13	RS1/16S563J		

====Circuit Symbol and No.====Part Name	Part No.
CAPACITORS	
C 1	CCSQCH6R0D50
C 2	CCSRCK2R0C50
C 4	CCSRCH820J50
C 6	CCSRCH820J50
C 8	CKSRYB103K25
C 9	CKSQYB104K16
C 10	CCSRCKR50C50
C 11	CEJA1R0M50
C 13	CKSRYB222K50
C 14	CCSRCH220J50
C 16	CCSRCH8R0D50
C 17	CKSRYB222K50
C 18	CKSRYB103K25
C 19	CKSRYB222K50
C 20	CKSRYB222K50
C 21	CEJA100M16
C 22	CCSRTH9R0D50
C 23	CCSRTH120J50
C 24	CCSRCH471J50
C 25	CKSRYB103K25
C 31	CKSRYB103K25
C 32	CKSQYB472K50
C 33	CCSRCH5R0C50
C 34	CKSQYB104K16
C 36	CCSRRH201J50
C 51	CKSRYB223K25
C 52	CKSRYB103K25
C 54	CCSRCH470J50
C 55	CKSQYB223K25
C 56	CKSQYB104K16
C 57	CKSRYB472K50
C 58	CEJA330M10
C 59	CKSRYB103K25
C 61	CCSRCH270J50
C 62	CKSRYB103K25
C 63	CEJAR15M50
C 101	CEJANP100M10
C 102	CKSRYB182K50
C 103	CKSRYB682K25
C 104	CEJA2R2M50
C 105	CKSRYB103K25
C 106	CCSRCH151J50
C 107	CKSRYB103K25
C 151	CKSRYB472K50
C 152	CKSQYB104K16
C 153	CEJA3R3M50
C 154	CKSQYB104K16
C 157	CEJA3R3M50
C 158	CKSYB474K16
C 159	CEJA220M6R3
C 160	CKSQYB104K16
C 161	CKSQYB104K16
C 162	CEJA3R3M50
C 163	CKSRYB102K50
C 170	CCSRCH100D50
C 201	CCSRCH471J50
C 202	CCSRCH100D50
C 203	CKSRYB332K50
C 204	CKSQYB473K16
C 205	CKSQYB473K16
C 206	CKSQYB104K16
C 207	CCSRCH560J50
C 209	CKSQYB104K16
C 211	CCSRCH101J50
C 212	CEJA470M6R3

====Circuit Symbol and No.====Part Name	Part No.
C 213	CKSRYB103K25
C 216	CCSRCH101J50
C 217	CEJA1R5M50
C 219	CCSRCH471J50
C 220	CKSRYB103K25
C 230	CKSRYB103K25
C 231	CCSRCH330J50
C 232	CCSRCH150J50
C 233	CKSQYB104K16
C 234	CEJA330M10
C 235	CKSRYB332K50
C 236	CKSQYB473K16
C 237	CCSRCH120J50
C 239	CKSRYB472K50
C 240	CEJAR47M50
C 241	CKSQYB104K16
C 242	CEJAR47M50
C 243	CEJAR33M50
C 244	CKSQYB473K16
C 245	CKSRYB123K25
C 246	CKSQYB473K16
C 250	CCSRCH471J50

A Unit Number : UWM6914(SCU-2456ZRN)
 Unit Name : Tuner Amp Unit

MISCELLANEOUS

IC 201	IC	NJM4558MD
IC 202	IC	NJM4558MD
IC 251	IC	NJM4558MD
IC 252	IC	NJM4558MD
IC 403	IC	NJM4558MD
IC 501	IC	LC72146M
IC 502	HIC Module	CWV1065
IC 551	IC	TDA7385
IC 701	IC	PE5157A
IC 751	IC	PMJ002A
IC 901	IC	PA2024A
IC 902	IC	PAJ001A
Q 201	Transistor	2SC2712
Q 202	Transistor	2SC2712
Q 203	Transistor	2SC2712
Q 204	Transistor	2SC2712
Q 205	Transistor	2SC2712
Q 206	Transistor	2SC2712
Q 251	Transistor	2SC2712
Q 252	Transistor	2SC2712
Q 253	Transistor	2SC2712
Q 254	Transistor	2SC2712
Q 255	Transistor	2SC2712
Q 256	Transistor	2SC2712
Q 401	Transistor	DTC143TK
Q 402	Transistor	DTC143TK
Q 403	Transistor	DTC143TK
Q 404	Transistor	DTC143TK
Q 405	Transistor	DTC343TK
Q 406	Transistor	DTC343TK
Q 409	Transistor	DTA114EK
Q 410	Transistor	DTA114EK
Q 411	Transistor	DTC343TK
Q 412	Transistor	DTC343TK
Q 501	Transistor	2SK208
Q 502	Transistor	2SC2712
Q 503	Transistor	2SK208
Q 504	Transistor	2SC2712
Q 505	Transistor	DTC124EK
Q 506	Transistor	DTC124EK

====Circuit Symbol and No.====Part Name	Part No.	====Circuit Symbol and No.====Part Name	Part No.
Q 507 Transistor	2SC2712	RESISTORS	
Q 508 Transistor	2SC2712		
Q 551 Transistor	DTC343TK	R 201	RS1/10S473J
Q 552 Transistor	DTC343TK	R 202	RS1/10S473J
Q 553 Transistor	DTC343TK	R 203	RS1/10S182J
		R 204	RS1/10S182J
		R 205	RS1/10S472J
Q 554 Transistor	DTC343TK		
Q 555 Transistor	DTC124EK		
Q 701 Transistor	DTA114EK	R 206	RS1/10S472J
Q 702 Transistor	DTA114EK	R 207	RD1/4PU472J
Q 703 Transistor	DTA114EK	R 208	RD1/4PU472J
		R 209	RS1/10S123J
		R 210	RS1/10S123J
Q 704 Transistor	DTA114EK		
Q 705 Transistor	DTA114EK		
Q 706 Transistor	DTA114EK	R 213	RS1/10S683J
Q 851 Transistor	DTC143TK	R 214	RS1/10S683J
Q 852 Transistor	DTC143TK	R 215	RS1/10S122J
		R 216	RS1/10S122J
		R 217	RS1/10S332J
Q 853 Transistor	DTC143TK		
Q 854 Transistor	DTC143TK		
Q 855 Transistor	DTA114EK	R 218	RS1/10S332J
Q 904 Transistor	2SC2712	R 221	RS1/10S103J
Q 905 Transistor	DTC114TK	R 222	RS1/10S103J
		R 223	RS1/10S683J
		R 224	RS1/10S683J
Q 906 Transistor	2SA1358		
Q 908 Transistor	2SC2712		
D 401 Chip Diode	MA151WA	R 225	RS1/10S122J
D 402 Diode	MA3043(M)	R 226	RS1/10S122J
D 403 Chip Diode	MA151WA	R 227	RS1/10S332J
		R 228	RS1/10S332J
		R 231	RS1/10S332J
D 404 Chip Diode	MA151WK		
D 501 Diode	MA3027(H)		
D 502 Diode	MA3027(H)	R 232	RS1/10S332J
D 503 Chip Diode	MA151WK	R 233	RS1/10S683J
D 504 Diode	MA3047(M)	R 234	RS1/10S683J
		R 235	RS1/10S122J
		R 236	RS1/10S122J
D 551 Chip Diode	MA151WA		
D 552 Chip Diode	MA151WA		
D 553 Diode	ERC05-10B	R 237	RS1/10S332J
D 554 Diode	ERA15-02VH	R 238	RS1/10S332J
D 555 Diode	ERA15-02VH	R 239	RS1/10S472J
		R 240	RS1/10S472J
		R 243	RD1/4PU222J
D 556 Diode	ERA15-02VH		
D 651 Diode	MA153		
D 652 Diode	MA153	R 244	RD1/4PU222J
D 653 Diode	MA153	R 245	RD1/4PU0R0J
D 654 Diode	MA153	R 246	RD1/4PU0R0J
		R 251	RS1/10S473J
		R 252	RS1/10S473J
D 655 Diode	MA153		
D 656 Diode	MA153		
D 657 Diode	MA153	R 253	RS1/10S122J
D 658 Diode	MA153	R 254	RS1/10S122J
D 659 Diode	MA153	R 255	RS1/10S472J
		R 256	RS1/10S472J
		R 257	RD1/4PU472J
D 660 Diode	MA153		
D 661 Diode	MA153		
D 662 Diode	MA153	R 258	RD1/4PU472J
D 663 Diode	MA153	R 259	RS1/10S821J
D 701 Diode	1SS133	R 260	RS1/10S821J
		R 263	RS1/10S683J
		R 264	RS1/10S683J
D 702 Diode	MA153		
D 703 Chip Diode	MA151WK		
D 704 Chip Diode	MA151WK	R 265	RS1/10S122J
D 705 Chip Diode	MA151WK	R 266	RS1/10S122J
D 851 Chip Diode	MA151WA	R 267	RS1/10S332J
		R 268	RS1/10S332J
		R 269	RS1/10S101J
D 901 Diode	ERA15-02VH		
D 907 Diode	1SS133		
L 501 Inductor	LAU100K	R 270	RS1/10S101J
L 502 Ferri-Inductor	LAU4R7K	R 273	RS1/10S683J
L 503 Ferri-Inductor	LAU4R7K	R 274	RS1/10S683J
		R 275	RS1/10S122J
		R 276	RS1/10S122J
L 504 Ferri-Inductor	LAU4R7K		
L 505 Ferri-Inductor	LAU2R2K		
L 551 Choke Coil 0.3mH	CTH1075	R 277	RS1/10S332J
L 701 Ferri-Inductor	LAU2R2K	R 278	RS1/10S332J
L 702 Ferri-Inductor	LAU2R2K	R 279	RS1/10S152J
		R 280	RS1/10S152J
		R 283	RS1/10S683J
X 501 Crystal Resonator 4.5MHz	CSS1011		
X 701 Ceramic Resonator 4.190MHz	CSS1361		
VR 501 Semi-fixed 2.2kΩ(B)	CCP1202		
AR 501 Fuse 10A	DSP-201M		
	CEK1136		

====Circuit Symbol and No.====Part Name	Part No.	====Circuit Symbol and No.====Part Name	Part No.
R 284	RS1/10S683J	R 556	RD1/4PU562J
R 285	RS1/10S122J	R 557	RD1/4PU0R0J
R 286	RS1/10S122J	R 558	RD1/4PU0R0J
R 287	RS1/10S332J	R 559	RS1/10S104J
R 288	RS1/10S332J	R 560	RS1/10S104J
R 289	RS1/10S472J	R 563	RS1/10S391J
R 290	RS1/10S472J	R 564	RS1/10S273J
R 291	RS1/10S683J	R 565	RS1/10S103J
R 292	RS1/10S683J	R 566	RS1/10S103J
R 401	RS1/10S822J	R 567	RS1/10S103J
R 402	RS1/10S822J	R 568	RS1/10S331J
R 403	RS1/10S102J	R 569	RA4C223J
R 404	RS1/10S102J	R 570	RD1/4PU102J
R 405	RS1/10S102J	R 571	RD1/4PU103J
R 406	RS1/10S102J	R 601	RA4C102J
R 407	RS1/10S473J	R 602	RS1/10S473J
R 408	RS1/10S473J	R 603	RS1/10S473J
R 409	RS1/10S152J	R 604	RS1/10S473J
R 410	RS1/10S152J	R 605	RS1/10S473J
R 411	RS1/10S682J	R 606	RS1/10S223J
R 412	RS1/10S682J	R 607	RS1/10S473J
R 421	RS1/10S122J	R 608	RS1/10S473J
R 422	RS1/10S122J	R 609	RS1/10S471J
R 423	RS1/10S223J	R 610	RS1/10S473J
R 424	RS1/10S223J	R 611	RS1/10S473J
R 425	RS1/10S223J	R 612	RS1/10S473J
R 426	RS1/10S223J	R 651	RS1/10S471J
R 435	RS1/10S223J	R 652	RS1/10S471J
R 436	RS1/10S223J	R 653	RS1/10S471J
R 437	RD1/4PU273J	R 654	RS1/10S471J
R 438	RD1/4PU273J	R 655	RS1/10S471J
R 439	RS1/10S223J	R 656	RS1/10S471J
R 440	RS1/10S223J	R 657	RS1/10S471J
R 441	RS1/10S273J	R 658	RS1/10S103J
R 442	RS1/10S273J	R 659	RS1/10S682J
R 452	RD1/4PU151J	R 660	RS1/10S682J
R 453	RS1/10S104J	R 661	RS1/10S103J
R 454	RD1/4PU152J	R 662	RS1/10S103J
R 455	RD1/4PU152J	R 663	RS1/10S103J
R 501	RS1/10S222J	R 664	RS1/10S473J
R 502	RS1/10S222J	R 665	RS1/10S221J
R 503	RS1/10S102J	R 666	RS1/10S221J
R 504	RS1/10S152J	R 667	RS1/10S221J
R 505	RS1/10S472J	R 668	RS1/10S221J
R 506	RS1/10S103J	R 669	RS1/10S221J
R 507	RS1/10S102J	R 670	RS1/10S221J
R 508	RS1/10S102J	R 671	RS1/10S221J
R 509	RS1/10S102J	R 672	RS1/10S471J
R 510	RS1/10S102J	R 673	RS1/10S471J
R 511	RS1/10S102J	R 674	RS1/10S471J
R 512	RS1/10S102J	R 675	RS1/10S471J
R 513	RS1/10S222J	R 676	RS1/10S471J
R 514	RS1/10S222J	R 677	RS1/10S471J
R 515	RS1/10S473J	R 678	RA4C473J
R 516	RS1/10S103J	R 680	RS1/10S0R0J
R 517	RS1/10S102J	R 683	RS1/10S0R0J
R 518	RS1/10S393J	R 684	RS1/10S0R0J
R 519	RS1/10S102J	R 685	RS1/10S2R2J
R 521	RS1/10S563J	R 686	RS1/10S2R2J
R 522	RS1/10S102J	R 687	RS1/10S2R2J
R 523	RD1/4PU151J	R 701	RS1/10S102J
R 524	RS1/10S0R0J	R 702	RS1/10S102J
R 525	RS1/10S0R0J	R 703	RS1/10S473J
R 540	RS1/10S103J	R 705	RS1/10S471J
R 542	RS1/10S0R0J	R 706	RS1/10S0R0J
R 551	RD1/4PU222J	R 707	RS1/10S471J
R 552	RD1/4PU222J	R 708	RS1/10S471J
R 553	RD1/4PU222J	R 709	RS1/10S471J
R 554	RD1/4PU222J	R 710	RA4C471J
R 555	RD1/4PU562J	R 713	RA4C471J

SCU-2456ZRN,2556ZRN

====Circuit Symbol and No.====Part Name	Part No.	====Circuit Symbol and No.====Part Name	Part No.
R 716	RA4C0R0J	C 206	CKSQYB183K50
R 717	RS1/10S102J	C 207	CKSQYB154K16
R 718	RS1/10S105J	C 208	CKSQYB154K16
R 719	RS1/10S471J	C 209	CKSQYB154K16
R 720	RS1/10S823J	C 210	CKSQYB154K16
R 721	RS1/10S0R0J	C 211	CKSQYB272K50
R 722	RS1/10S471J	C 212	CKSQYB272K50
R 723	RS1/10S471J	C 213	CKSQYB392K50
R 724	RS1/10S473J	C 214	CKSQYB392K50
R 725	RS1/10S471J	C 215	CKSQYB821K50
R 726	RS1/10S471J	C 216	CKSQYB821K50
R 727	RS1/10S0R0J	C 251	CKSQYB821K50
R 728	RS1/10S0R0J	C 252	CKSQYB821K50
R 729	RS1/10S223J	C 253	CKSQYB474K16
R 730	RS1/10S473J	C 254	CKSQYB474K16
R 731	RD1/4PU101J	C 255	CKSQYB333K50
R 732	RS1/10S472J	C 256	CKSQYB333K50
R 733	RS1/10S473J	C 257	CKSQYB154K16
R 734	RS1/10S102J	C 258	CKSQYB154K16
R 735	RS1/10S102J	C 259	CKSQYB333K50
R 751	RS1/10S681J	C 260	CKSQYB333K50
R 752	RS1/10S681J	C 261	CKSQYB822K50
R 753	RS1/10S273J	C 262	CKSQYB822K50
R 754	RS1/10S273J	C 263	CKSQYB103K50
R 755	RS1/10S101J	C 264	CKSQYB103K50
R 756	RS1/10S101J	C 265	CKSQYB821K50
R 757	RS1/10S152J	C 266	CKSQYB821K50
R 758	RS1/10S123J	C 401	CKSQYB223K50
R 759	RS1/10S153J	C 402	CKSQYB223K50
R 760	RA4C472J	C 403	CKSQYB153K50
R 761	RS1/10S102J	C 404	CKSQYB153K50
R 851	RS1/10S393J	C 405	CEAT2R2M50
R 852	RS1/10S393J	C 406	CEAT2R2M50
R 853	RS1/10S272J	C 427	CEAT100M50
R 854	RS1/10S272J	C 428	CEAT100M50
R 855	RS1/10S332J	C 429	CCSQCH101J50
R 856	RS1/10S332J	C 430	CCSQCH101J50
R 857	RS1/10S220J	C 434	CEAT221M6R3
R 901	RS1/10S154J	C 435	CKSQYB103K50
R 902	RS1/10S623J	C 501	CCH1250
R 903	RS1/10S124J	C 502	CKSQYB103K50
R 904	RS1/10S513J	C 503	CFTNA474J50
R 905	RS1/10S154J	C 504	CKSQYB103K50
R 906	RS1/10S563J	C 505	CCSQCH120J50
R 907	RS1/10S124J	C 506	CCSQCH120J50
R 908	RS1/10S683J	C 508	CKSQYB223K50
R 909	RS1/10S102J	C 509	CKSQYB223K50
R 914	RS1/10S153J	C 511	CEATR47M50
R 915	RS1/10S152J	C 512	CKSQYB103K50
R 916	RS1/10S223J	C 513	CEAT100M50
R 917	RS1/10S472J	C 514	CKSQYB104K50
R 920	RS1/10S272J	C 515	CCSQCH101J50
R 921	RS1/10S122J	C 516	CCSQCH101J50
R 922	RS1/10S103J	C 518	CKSQYB473K50
R 923	RS1/10S473J	C 519	CKSQYB103K50
R 924	RS1/10S473J	C 521	CKSQYB104K50
R 925	RS1/10S473J	C 522	CKSYB105K16
R 927	RS1/10S473J	C 525	CKLSR473K16
		C 526	CKSQYB104K50
		C 527	CKSQYB223K50
CAPACITORS			
C 201	CKSQYB821K50	C 528	CKSQYB223K50
C 202	CKSQYB821K50	C 533	CCSQCH101J50
C 203	CKSQYB274K16	C 534	CEAT100M50
C 204	CKSQYB274K16	C 535	CKSQYB104K50
C 205	CKSQYB183K50	C 536	CEATR22M50

====Circuit Symbol and No.====Part Name	Part No.	====Circuit Symbol and No.====Part Name	Part No.
C 537	CEAT101M16	C 851	CEAT100M50
C 538	CKSQYB103K50	C 852	CEAT100M50
C 539	CKSQYB472K50	C 853	CKSQYB104K50
C 551	CEAT1R0M50	C 854	CKSQYB104K50
C 552	CEAT1R0M50	C 901	CEAT331M10
C 553	CEAT1R0M50	C 902	CASA680K10
C 554	CEAT1R0M50	C 903	CEAT101M10
C 555	CFTNA224J50	C 904	CEAT470M10
C 556	CFTNA224J50	C 905	CEAT1R0M50
C 557	CFTNA224J50	C 906	CEAT102M16
C 558	CFTNA224J50	C 907	CKSQYB224K16
C 559	CKSQYB222K50	C 912	CEAT2R2M50
C 560	CFTNA224J50	C 913	CSZA220M16
C 561	CEAT100M50	C 914	CKSQYB473K50
C 562	CEAT1R0M50	C 916	CKSQYB473K50
C 563	CEAT2R2M50	C 917	CEAT330M10
C 564	CKSQYB104K50	C 918	CEAT470M10
C 565	CEAT472M16		
C 567	CKSQYB473K50		
C 568	CKSQYB473K50		
C 681	CKSQYB104K50		
C 682	CKSQYB104K50		
C 701	CKSQYB473K50		
C 702	CKSQYB473K50		
C 703	CEAT100M50		
C 704	CKSQYB102K50		
C 705	CKSQYB473K50		
C 706	CKSQYB473K50		
C 707	CEAT4R7M50		
C 751	CEJA1R0M50		
C 752	CEJA1R0M50		
C 753	CKSQYB272K50		
C 754	CKSQYB272K50		
C 755	CEAT100M50		
C 756	CEAT100M50		
C 757	CKSQYB152K50		
C 758	CKSQYB152K50		
C 759	CKSQYB183K50		
C 760	CKSQYB183K50		
C 761	CCSQCH221J50		
C 762	CCSQCH221J50		
C 763	CKSQYB224K16		
C 764	CKSQYB224K16		
C 765	CKSQYB332K50		
C 766	CKSQYB332K50		
C 767	CCSQCH101J50		
C 768	CCSQCH101J50		
C 769	CEJANP2R2M50		
C 770	CEJANP2R2M50		
C 771	CKSQYB333K50		
C 772	CKSQYB333K50		
C 773	CEAT100M50		
C 774	CEAT100M50		
C 775	CEJANP2R2M50		
C 776	CEJANP2R2M50		
C 777	CEJANP2R2M50		
C 778	CEJANP2R2M50		
C 779	CKSQYB103K50		
C 780	CEAT100M50		
C 781	CKSQYB104K50		
C 782	CEAT100M50		
C 783	CEAT100M50		
C 784	CKSQYB104K50		
C 785	CEAT101M16		
C 786	CEAT2R2M50		
C 851	CEAT100M50		
C 852	CEAT100M50		
C 853	CKSQYB104K50		
C 854	CKSQYB104K50		
C 901	CEAT331M10		
C 902	CASA680K10		
C 903	CEAT101M10		
C 904	CEAT470M10		
C 905	CEAT1R0M50		
C 906	CEAT102M16		
C 907	CKSQYB224K16		
C 912	CEAT2R2M50		
C 913	CSZA220M16		
C 914	CKSQYB473K50		
C 916	CKSQYB473K50		
C 917	CEAT330M10		
C 918	CEAT470M10		

A Unit Number : UWM6917(SCU-2556ZRN)
Unit Name : Tuner Amp Unit

MISCELLANEOUS

IC 201	IC	NJM4558MD
IC 202	IC	NJM4558MD
IC 251	IC	NJM4558MD
IC 252	IC	NJM4558MD
IC 403	IC	NJM4558MD
IC 404	IC	NJM4558MD
IC 501	IC	LC72146M
IC 502	HIC Module	CWV1065
IC 551	IC	PAL005A
IC 701	IC	PE5157A
IC 751	IC	PMJ002A
IC 901	IC	PA2024A
IC 902	IC	PAJ001A
Q 201	Transistor	2SC2712
Q 202	Transistor	2SC2712
Q 203	Transistor	2SC2712
Q 204	Transistor	2SC2712
Q 205	Transistor	2SC2712
Q 206	Transistor	2SC2712
Q 251	Transistor	2SC2712
Q 252	Transistor	2SC2712
Q 253	Transistor	2SC2712
Q 254	Transistor	2SC2712
Q 255	Transistor	2SC2712
Q 256	Transistor	2SC2712
Q 401	Transistor	DTC143TK
Q 402	Transistor	DTC143TK
Q 403	Transistor	DTC143TK
Q 404	Transistor	DTC143TK
Q 405	Transistor	DTC343TK
Q 406	Transistor	DTC343TK
Q 407	Transistor	DTC343TK
Q 408	Transistor	DTC343TK
Q 409	Transistor	DTA114EK
Q 410	Transistor	DTA114EK
Q 411	Transistor	DTC343TK
Q 412	Transistor	DTC343TK
Q 501	Transistor	2SK208
Q 502	Transistor	2SC2712
Q 503	Transistor	2SK208
Q 504	Transistor	2SC2712
Q 505	Transistor	DTC124EK
Q 506	Transistor	DTC124EK
Q 507	Transistor	2SC2712
Q 508	Transistor	2SC2712

====Circuit Symbol and No.====Part Name	Part No.	====Circuit Symbol and No.====Part Name	Part No.
Q 551 Transistor	DTC343TK	RESISTORS	
Q 552 Transistor	DTC343TK		
Q 553 Transistor	DTC343TK		
Q 554 Transistor	DTC343TK		
Q 555 Transistor	DTC124EK		
Q 701 Transistor	DTA114EK		
Q 702 Transistor	DTA114EK		
Q 703 Transistor	DTA114EK		
Q 704 Transistor	DTA114EK		
Q 705 Transistor	DTA114EK		
Q 706 Transistor	DTA114EK	R 201	RS1/10S473J
Q 851 Transistor	DTC143TK	R 202	RS1/10S473J
Q 852 Transistor	DTC143TK	R 203	RS1/10S182J
Q 853 Transistor	DTC143TK	R 204	RS1/10S182J
Q 854 Transistor	DTC143TK	R 205	RS1/10S472J
Q 855 Transistor	DTA114EK	R 206	RS1/10S472J
Q 904 Transistor	2SC2712	R 207	RD1/4PU472J
Q 905 Transistor	DTC114TK	R 208	RD1/4PU472J
Q 906 Transistor	2SA1358	R 209	RS1/10S123J
Q 908 Transistor	2SC2712	R 210	RS1/10S123J
D 401 Chip Diode	MA151WA	R 213	RS1/10S683J
D 402 Diode	MA3043(M)	R 214	RS1/10S683J
D 403 Chip Diode	MA151WA	R 215	RS1/10S122J
D 404 Chip Diode	MA151WK	R 216	RS1/10S122J
D 501 Diode	MA3027(H)	R 217	RS1/10S332J
D 502 Diode	MA3027(H)	R 218	RS1/10S332J
D 503 Chip Diode	MA151WK	R 221	RS1/10S103J
D 504 Diode	MA3047(M)	R 222	RS1/10S103J
D 551 Chip Diode	MA151WA	R 223	RS1/10S683J
D 552 Chip Diode	MA151WA	R 224	RS1/10S683J
D 553 Diode	ERC05-10B	R 225	RS1/10S122J
D 554 Diode	ERA15-02VH	R 226	RS1/10S122J
D 555 Diode	ERA15-02VH	R 227	RS1/10S332J
D 556 Diode	ERA15-02VH	R 228	RS1/10S332J
D 651 Diode	MA153	R 231	RS1/10S332J
D 652 Diode	MA153	R 232	RS1/10S332J
D 653 Diode	MA153	R 233	RS1/10S683J
D 654 Diode	MA153	R 234	RS1/10S683J
D 655 Diode	MA153	R 235	RS1/10S122J
D 656 Diode	MA153	R 236	RS1/10S122J
D 657 Diode	MA153	R 237	RS1/10S332J
D 658 Diode	MA153	R 238	RS1/10S332J
D 659 Diode	MA153	R 239	RS1/10S472J
D 660 Diode	MA153	R 240	RS1/10S472J
D 661 Diode	MA153	R 243	RD1/4PU222J
D 662 Diode	MA153	R 244	RD1/4PU222J
D 663 Diode	MA153	R 245	RD1/4PU0R0J
D 701 Diode	1SS133	R 246	RD1/4PU0R0J
D 702 Diode	MA153	R 251	RS1/10S473J
D 703 Chip Diode	MA151WK	R 252	RS1/10S473J
D 704 Chip Diode	MA151WK	R 253	RS1/10S122J
D 705 Chip Diode	MA151WK	R 254	RS1/10S122J
D 851 Chip Diode	MA151WA	R 255	RS1/10S472J
D 901 Diode	ERA15-02VH	R 256	RS1/10S472J
D 907 Diode	1SS133	R 257	RD1/4PU472J
L 501 Inductor	LAU100K	R 258	RD1/4PU472J
L 502 Ferri-Inductor	LAU4R7K	R 259	RS1/10S821J
L 503 Ferri-Inductor	LAU4R7K	R 260	RS1/10S821J
L 504 Ferri-Inductor	LAU4R7K	R 263	RS1/10S683J
L 505 Ferri-Inductor	LAU2R2K	R 264	RS1/10S683J
L 551 Choke Coil 0.3mH	CTH1075	R 265	RS1/10S122J
L 701 Ferri-Inductor	LAU2R2K	R 266	RS1/10S122J
L 702 Ferri-Inductor	LAU2R2K	R 267	RS1/10S332J
X 501 Crystal Resonator 4.5MHz	CSS1011	R 268	RS1/10S332J
X 701 Ceramic Resonator 4.190MHz	CSS1361	R 269	RS1/10S101J
VR 501 Semi-fixed 2.2kΩ(B)	CCP1202	R 270	RS1/10S101J
AR 501 Fuse 10A	DSP-201M	R 273	RS1/10S683J
	CEK1136	R 274	RS1/10S683J
		R 275	RS1/10S122J
		R 276	RS1/10S122J
		R 277	RS1/10S332J
		R 278	RS1/10S332J
		R 279	RS1/10S152J
		R 280	RS1/10S152J
		R 283	RS1/10S683J

====Circuit Symbol and No.====Part Name	Part No.	====Circuit Symbol and No.====Part Name	Part No.
R 284	RS1/10S683J	R 524	RS1/10S0R0J
R 285	RS1/10S122J	R 525	RS1/10S0R0J
R 286	RS1/10S122J	R 540	RS1/10S103J
R 287	RS1/10S332J	R 542	RS1/10S0R0J
R 288	RS1/10S332J	R 551	RD1/4PU222J
R 289	RS1/10S472J	R 552	RD1/4PU222J
R 290	RS1/10S472J	R 553	RD1/4PU222J
R 291	RS1/10S683J	R 554	RD1/4PU222J
R 292	RS1/10S683J	R 555	RD1/4PU562J
R 401	RS1/10S822J	R 556	RD1/4PU562J
R 402	RS1/10S822J	R 557	RD1/4PU0R0J
R 403	RS1/10S102J	R 558	RD1/4PU0R0J
R 404	RS1/10S102J	R 559	RS1/10S104J
R 405	RS1/10S102J	R 560	RS1/10S104J
R 406	RS1/10S102J	R 563	RS1/10S391J
R 407	RS1/10S473J	R 564	RS1/10S273J
R 408	RS1/10S473J	R 565	RS1/10S103J
R 409	RS1/10S152J	R 566	RS1/10S103J
R 410	RS1/10S152J	R 567	RS1/10S103J
R 411	RS1/10S682J	R 568	RS1/10S331J
R 412	RS1/10S682J	R 569	RA4C223J
R 421	RS1/10S122J	R 570	RD1/4PU102J
R 422	RS1/10S122J	R 571	RD1/4PU103J
R 423	RS1/10S223J	R 601	RA4C102J
R 424	RS1/10S223J	R 602	RS1/10S473J
R 425	RS1/10S223J	R 603	RS1/10S473J
R 426	RS1/10S223J	R 604	RS1/10S473J
R 435	RS1/10S223J	R 605	RS1/10S473J
R 436	RS1/10S223J	R 606	RS1/10S223J
R 437	RD1/4PU273J	R 607	RS1/10S473J
R 438	RD1/4PU273J	R 608	RS1/10S473J
R 439	RS1/10S223J	R 609	RS1/10S471J
R 440	RS1/10S223J	R 610	RS1/10S473J
R 441	RS1/10S273J	R 611	RS1/10S473J
R 442	RS1/10S273J	R 612	RS1/10S473J
R 443	RS1/10S223J	R 651	RS1/10S471J
R 444	RS1/10S473J	R 652	RS1/10S471J
R 445	RS1/10S473J	R 653	RS1/10S471J
R 446	RS1/10S182J	R 654	RS1/10S471J
R 447	RS1/10S152J	R 655	RS1/10S471J
R 448	RS1/10S223J	R 656	RS1/10S471J
R 449	RS1/10S223J	R 657	RS1/10S471J
R 450	RS1/10S223J	R 658	RS1/10S103J
R 451	RS1/10S273J	R 659	RS1/10S682J
R 452	RD1/4PU151J	R 660	RS1/10S682J
R 453	RS1/10S104J	R 661	RS1/10S103J
R 454	RD1/4PU151J	R 662	RS1/10S103J
R 455	RD1/4PU151J	R 663	RS1/10S103J
R 501	RS1/10S222J	R 664	RS1/10S473J
R 502	RS1/10S222J	R 665	RS1/10S221J
R 503	RS1/10S102J	R 666	RS1/10S221J
R 504	RS1/10S152J	R 667	RS1/10S221J
R 505	RS1/10S472J	R 668	RS1/10S221J
R 506	RS1/10S103J	R 669	RS1/10S221J
R 507	RS1/10S102J	R 670	RS1/10S221J
R 508	RS1/10S102J	R 671	RS1/10S221J
R 509	RS1/10S102J	R 672	RS1/10S471J
R 510	RS1/10S102J	R 673	RS1/10S471J
R 511	RS1/10S102J	R 674	RS1/10S471J
R 512	RS1/10S102J	R 675	RS1/10S471J
R 513	RS1/10S222J	R 676	RS1/10S471J
R 514	RS1/10S222J	R 677	RS1/10S471J
R 515	RS1/10S473J	R 678	RA4C473J
R 516	RS1/10S103J	R 680	RS1/10S0R0J
R 517	RS1/10S102J	R 683	RS1/10S0R0J
R 518	RS1/10S393J	R 684	RS1/10S0R0J
R 519	RS1/10S102J	R 685	RS1/10S2R2J
R 521	RS1/10S563J	R 686	RS1/10S2R2J
R 522	RS1/10S102J	R 687	RS1/10S2R2J
R 523	RD1/4PU151J	R 701	RS1/10S102J

====Circuit Symbol and No.====Part Name	Part No.	====Circuit Symbol and No.====Part Name	Part No.
R 702	RS1/10S102J	CAPACITORS	
R 704	RS1/10S473J		
R 705	RS1/10S471J	C 201	CKSQYB821K50
R 706	RS1/10S0R0J	C 202	CKSQYB821K50
R 707	RS1/10S471J	C 203	CKSQYB274K16
		C 204	CKSQYB274K16
R 708	RS1/10S471J	C 205	CKSQYB183K50
R 709	RS1/10S471J		
R 710	RA4C471J	C 206	CKSQYB183K50
R 713	RA4C471J	C 207	CKSQYB154K16
R 716	RA4C0R0J	C 208	CKSQYB154K16
		C 209	CKSQYB154K16
R 717	RS1/10S102J	C 210	CKSQYB154K16
R 718	RS1/10S105J		
R 719	RS1/10S471J	C 211	CKSQYB272K50
R 720	RS1/10S823J	C 212	CKSQYB272K50
R 721	RS1/10S0R0J	C 213	CKSQYB392K50
		C 214	CKSQYB392K50
R 722	RS1/10S471J	C 215	CKSQYB821K50
R 723	RS1/10S471J		
R 724	RS1/10S473J	C 216	CKSQYB821K50
R 725	RS1/10S471J	C 251	CKSQYB821K50
R 726	RS1/10S471J	C 252	CKSQYB821K50
		C 253	CKSQYB474K16
R 727	RS1/10S0R0J	C 254	CKSQYB474K16
R 728	RS1/10S0R0J		
R 729	RS1/10S223J	C 255	CKSQYB333K50
R 730	RS1/10S473J	C 256	CKSQYB333K50
R 731	RD1/4PU101J	C 257	CKSQYB154K16
		C 258	CKSQYB154K16
R 732	RS1/10S472J	C 259	CKSQYB333K50
R 733	RS1/10S473J		
R 734	RS1/10S102J	C 260	CKSQYB333K50
R 735	RS1/10S102J	C 261	CKSQYB822K50
R 751	RS1/10S681J	C 262	CKSQYB822K50
		C 263	CKSQYB103K50
R 752	RS1/10S681J	C 264	CKSQYB103K50
R 753	RS1/10S273J		
R 754	RS1/10S273J	C 265	CKSQYB821K50
R 755	RS1/10S101J	C 266	CKSQYB821K50
R 756	RS1/10S101J	C 401	CKSQYB223K50
		C 402	CKSQYB223K50
R 757	RS1/10S152J	C 403	CKSQYB153K50
R 758	RS1/10S123J		
R 759	RS1/10S153J	C 404	CKSQYB153K50
R 760	RA4C472J	C 405	CEAT2R2M50
R 761	RS1/10S102J	C 406	CEAT2R2M50
		C 427	CEAT100M50
R 851	RS1/10S393J	C 428	CEAT100M50
R 852	RS1/10S393J		
R 853	RS1/10S272J	C 429	CCSQCH101J50
R 854	RS1/10S272J	C 430	CCSQCH101J50
R 855	RS1/10S332J	C 431	CEAT1R0M50
		C 432	CCSQCH560J50
R 856	RS1/10S332J	C 433	CEAT1R0M50
R 857	RS1/10S220J		
R 901	RS1/10S154J	C 434	CEAT221M6R3
R 902	RS1/10S623J	C 435	CKSQYB103K50
R 903	RS1/10S124J	C 501	CCH1250
		C 502	CKSQYB103K50
R 904	RS1/10S513J	C 503	CFTNA474J50
R 905	RS1/10S154J		
R 906	RS1/10S563J	C 504	CKSQYB103K50
R 907	RS1/10S124J	C 505	CCSQCH120J50
R 908	RS1/10S683J	C 506	CCSQCH120J50
		C 508	CKSQYB223K50
R 909	RS1/10S102J	C 509	CKSQYB223K50
R 914	RS1/10S153J		
R 915	RS1/10S152J	C 511	CEATR47M50
R 916	RS1/10S223J	C 512	CKSQYB103K50
R 917	RS1/10S472J	C 513	CEAT100M50
		C 514	CKSQYB104K50
R 920	RS1/10S272J	C 515	CCSQCH101J50
R 921	RS1/10S122J		
R 922	RS1/10S103J	C 516	CCSQCH101J50
R 923	RS1/10S473J	C 518	CKSQYB473K50
R 924	RS1/10S473J	C 519	CKSQYB103K50
		C 521	CKSQYB104K50
R 925	RS1/10S473J	C 522	CKSYB105K16
R 927	RS1/10S473J		

4.7µF/16V

====Circuit Symbol and No.====Part Name	Part No.	====Circuit Symbol and No.====Part Name	Part No.
C 525	CKLSR473K16	C 784	CKSQYB104K50
C 526	CKSQYB104K50	C 785	CEAT101M16
C 527	CKSQYB223K50	C 786	CEAT2R2M50
C 528	CKSQYB223K50	C 851	CEAT100M50
C 533	CCSQCH101J50	C 852	CEAT100M50
C 534	CEAT100M50	C 853	CKSQYB104K50
C 535	CKSQYB104K50	C 854	CKSQYB104K50
C 536	CEATR22M50	C 901	CEAT331M10
C 537	CEAT101M16	C 902	CASA680K10
C 538	CKSQYB103K50	C 903	CEAT101M10
C 539	CKSQYB472K50	C 904	CEAT470M10
C 551	CEAT1R0M50	C 905	CEAT1R0M50
C 552	CEAT1R0M50	C 906	CEAT102M16
C 553	CEAT1R0M50	C 907	CKSQYB224K16
C 554	CEAT1R0M50	C 912	CEAT2R2M50
C 555	CFTNA224J50	C 913	CSZA220M16
C 556	CFTNA224J50	C 914	CKSQYB473K50
C 557	CFTNA224J50	C 916	CKSQYB473K50
C 558	CFTNA224J50	C 917	CEAT330M10
C 559	CKSQYB222K50	C 918	CEAT470M10
C 560	CFTNA105J50		
C 561	CEAT100M50		
C 562	CEAT1R0M50		
C 563	CEAT2R2M50		
C 564	CKSQYB104K50		
C 565	CEAT472M16		
C 567	CKSQYB473K50		
C 568	CKSQYB473K50		
C 681	CKSQYB104K50		
C 682	CKSQYB104K50		
C 701	CKSQYB473K50		
C 702	CKSQYB473K50		
C 703	CEAT100M50		
C 704	CKSQYB102K50		
C 705	CKSQYB473K50		
C 706	CKSQYB473K50		
C 707	CEAT4R7M50		
C 751	CEJA1R0M50		
C 752	CEJA1R0M50		
C 753	CKSQYB272K50		
C 754	CKSQYB272K50		
C 755	CEAT100M50		
C 756	CEAT100M50		
C 757	CKSQYB152K50		
C 758	CKSQYB152K50		
C 759	CKSQYB183K50		
C 760	CKSQYB183K50		
C 761	CCSQCH221J50		
C 762	CCSQCH221J50		
C 763	CKSQYB224K16		
C 764	CKSQYB224K16		
C 765	CKSQYB332K50		
C 766	CKSQYB332K50		
C 767	CCSQCH101J50		
C 768	CCSQCH101J50		
C 769	CEJANP2R2M50		
C 770	CEJANP2R2M50		
C 771	CKSQYB333K50		
C 772	CKSQYB333K50		
C 773	CEAT100M50		
C 774	CEAT100M50		
C 775	CEJANP2R2M50		
C 776	CEJANP2R2M50		
C 777	CEJANP2R2M50		
C 778	CEJANP2R2M50		
C 779	CKSQYB103K50		
C 780	CEAT100M50		
C 781	CKSQYB104K50		
C 782	CEAT100M50		
C 783	CEAT100M50		

6. ADJUSTMENT

● Connection Diagram

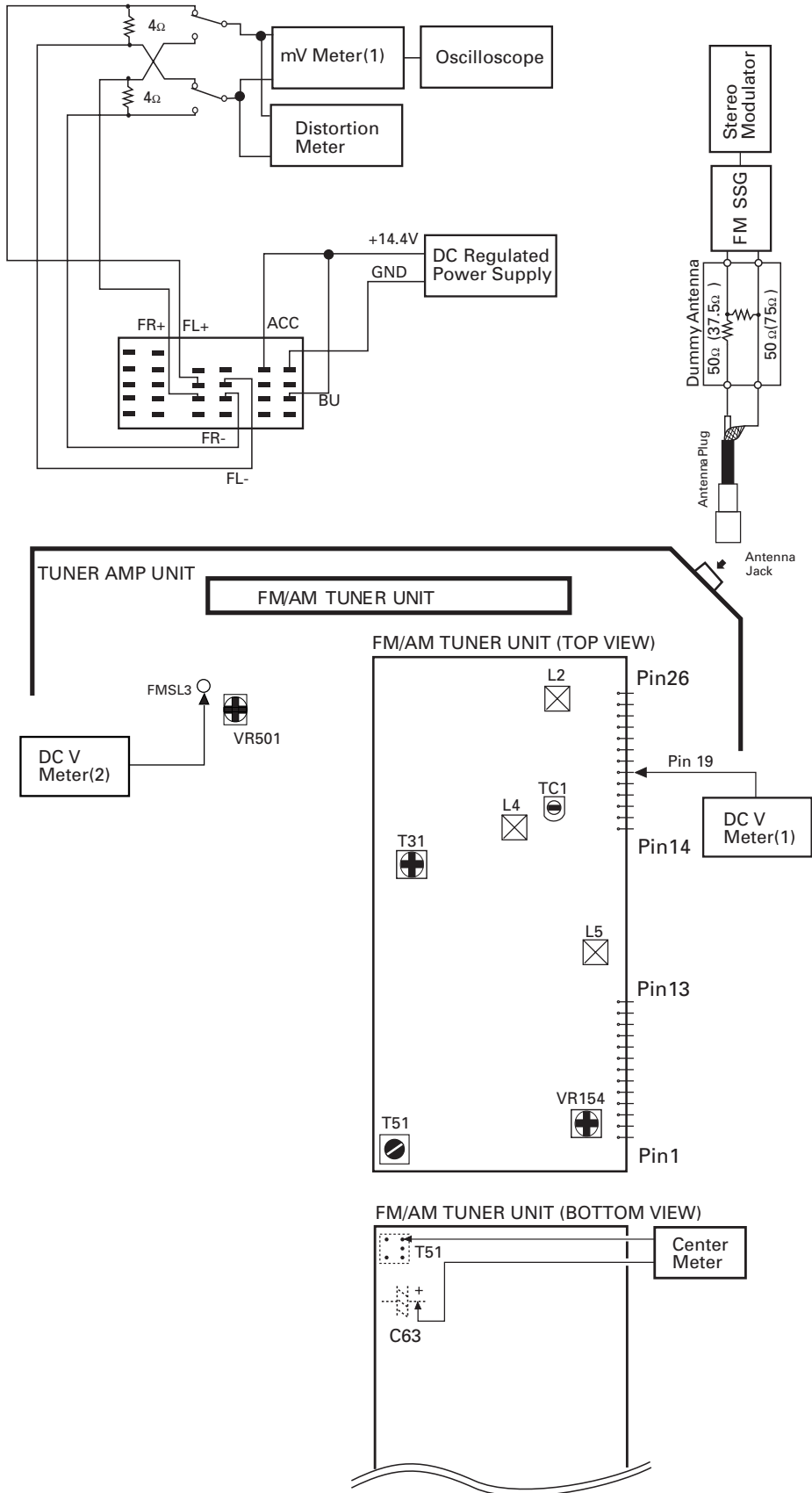

FM ADJUSTMENT

Modulation M:MONO MOD., 400Hz 30%(22.5kHz Dev.) or 400Hz 100%(75kHz Dev.)

S:STEREO MOD., 1kHz, L or R=30%(20.25kHz+7.5kHz Dev.)

NOTE:Before proceeding to further adjustments after switching power ON, let the tuner run for ten minutes to allow the circuits to stabilize.

	No.	FM SSG		Displayed	Adjustment Point	Adjustment Method (Switch Position)
		Frequency(MHz)	Level(dBf)	Frequency(MHz)		
TUN Volt	1	108.0	L5	DC V Meter(1) : 6V
IF	2	98.1 M	60—100	98.1	T51	Center Meter : 0
ANT Coil	3	98.1 M	5	98.1	L2	mV Meter(1) : Maximum
RF Coil	4	98.1 M	5	98.1	L4	mV Meter(1) : Maximum
RF Trimmer	5	129.3 M	60—80	107.9	TC1	mV Meter(1) : Minimum
	6	RF Coil and RF Trimmer shall be adjusted twice or more				
IFT	7	98.1 M	5	98.1	T31	mV Meter(1) : Maximum (STEREO MODE)
ARC	8	98.1 S	40	98.1	VR154	mV Meter(1) : Separation 5dB (STEREO MODE)

FMSL ADJUSTMENT

Modulation MONO MOD., 400Hz 100%(75kHz Dev.)

	No.	FM SSG		Displayed	Adjustment Point	Adjustment Method (Switch Position)
		Frequency(MHz)	Level(dBf)	Frequency(MHz)		
FMSL	1	98.1 M	25	98.1	VR501	DC V Meter(2) : 1.25V±0.05V

7. GENERAL INFORMATION

7.1 CONNECTOR FUNCTION DESCRIPTION

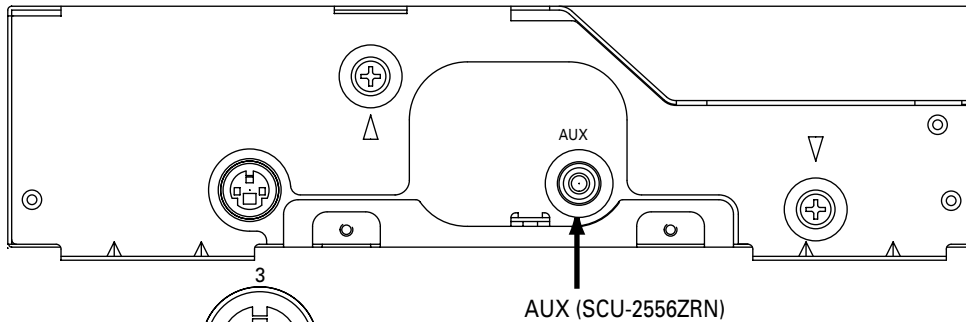

HEADPHONE TRANSMITTER	
1	LEFT CHANNEL
2	RIGHT CHANNEL
3	COMMON

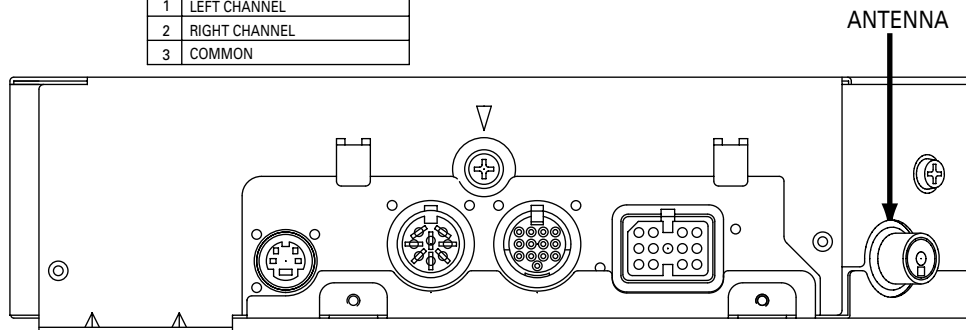

HEADPHONE TRANSMITTER	
1	LEFT CHANNEL
2	RIGHT CHANNEL
3	COMMON

DISPLAY	
1	GND
2	BDATA
3	BSCCK(Bus synchronisation clock)
4	BRXEN(Bus reception enable)
5	BSET(Bus set)
6	BINH(Bus inhibit)
7	GND
8	GND

CASSETTE PLAYER	
1	AUDIO L-
2	AUDIO L+
3	AUDIO R-
4	AUDIO R+
5	AUDIO Lch SHIELD
6	AUDIO Rch SHIELD
7	MUTE TO HEAD UNIT
8	GND
9	BSRQ(Bus service request)
10	BRST(Bus reset)
11	BRXEN(Bus reception enable)
12	BSCCK(Bus synchronisation clock)
13	BDATA
E	SHIELD GND

M-CD PLAYER	
1	AUDIO Lch SHIELD
2	AUDIO Rch SHIELD
3	GND
4	BSRQ (Bus service request)
5	AUDIO L+
6	AUDIO L-
7	NC
8	BRST(Bus reset)
9	BRXEN (Bus reception enable)
10	AUDIO R+
11	AUDIO R-
12	BSCCK(Bus synchronisation clock)
13	BDATA

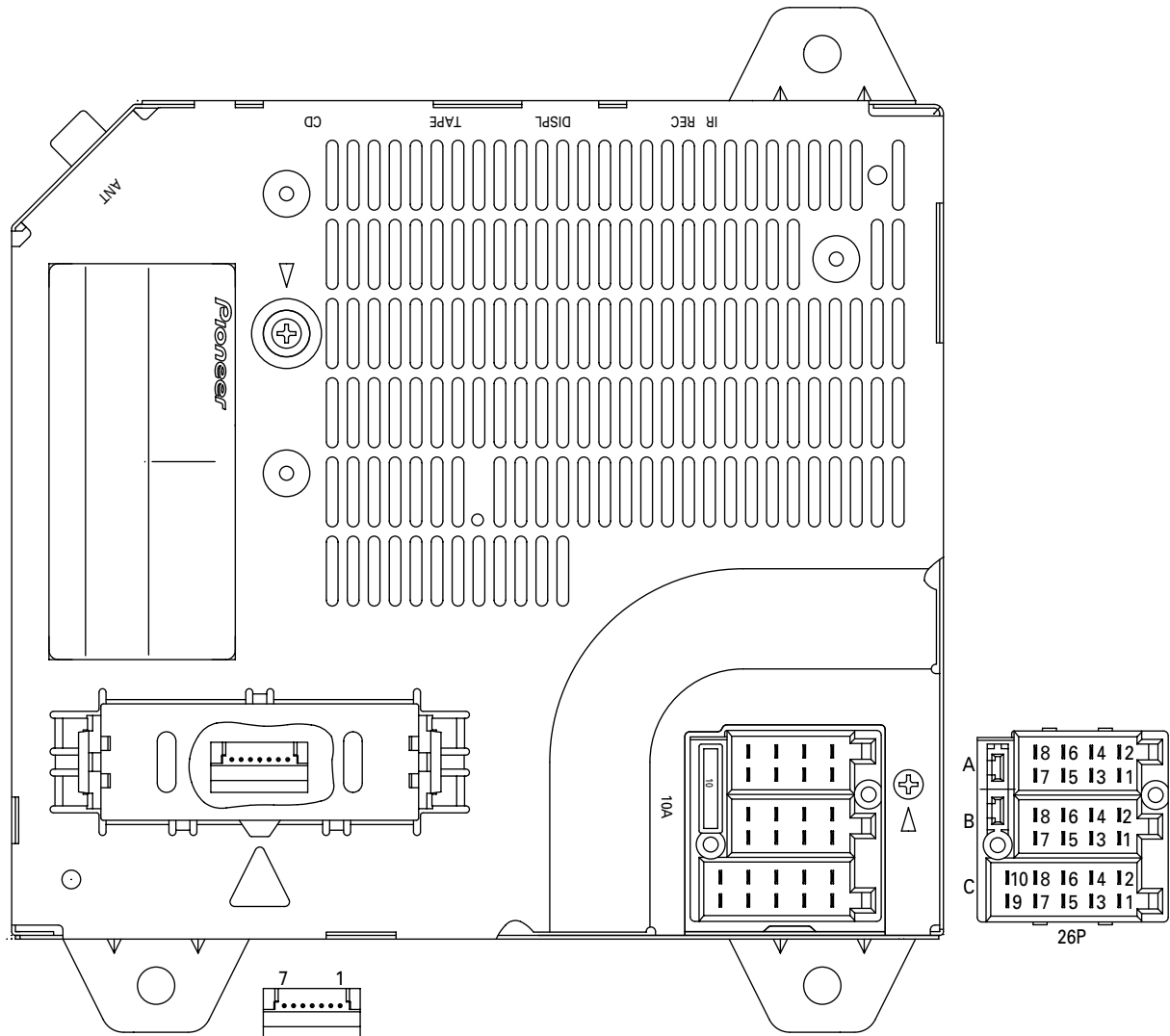

TRANSMITTER INTERFACE	
7	+8.5V
6	RIGHT OUT
5	LEFT OUT
4	GND
3	COMMON
2	RIGHT IN
1	LEFT IN

A1	NC	B1	RR+	C1	NC
A2	NC	B2	RR-	C2	NC
A3	TEL MUTE	B3	FR+	C3	NC
A4	+BACKUP	B4	FR-	C4	GND
A5	NC	B5	FL+	C5	L0
A6	NC	B6	FL-	C6	IN2
A7	+ACC	B7	RL+	C7	L1
A8	GND	B8	RL-	C8	IN0
				C9	L5
				C10	IN1

7.2 IC

● Pin Functions(PE5157A)

Pin No.	Pin Name	I/O	Format	Function and Operation
1	AVPOW	O	C	A Vref watching terminal
2	PEE	O	C	Beep tone output
3	BRXEN	I/O	C	Communication reception enable input/output
4	BINH	O	C	Communication data input inhibit
5	A/B	I		Model select
6	AUXMUTE	O	C	AUX mute
7	MUTE	O	C	Synthesis mute output
8	BSET	O	C	BUS communication reset output
9	VSS			GND
10	NC			Not used
11	ACCMUTE	O	C	ACC ON mute
12	NC			Not used
13	BRST	O	C	Reset output
14	AMPMUTE	O	C	Amp Mute output
15	SYSPW	O	C	System power supply control output
16	PCE	O	C	Chip enable output for PLL IC
17	AM/FM	O	C	AM/FM select output
18	BSRQ	I		Communication request input
19	RDSSEL	O	C	Select output for RDS IC
20	RDSRST	O	C	Reset output for RDS IC
21	RDSEN	O	C	Enable output for RDS IC
22,23	KDT0,1	I		Key data 0,1
24	VSS			GND
25	KDT2	I		Key data 2
26	NC			Connect to GND
27-29	KST0-2	O	C	Key strobe 0-2
30	NC			Not used
31	VDT	O	C	Data output for electronic volume
32	VST	O	C	Strobe pulse output for electronic volume
33	VCK	O	C	Clock output for electronic volume
34	TMUTE	O	C	Tuner mute output
35	RESET	I		Reset input
36	REMIN	I		Remote control pulse input
37	BSENS	I		Back up power sense input
38	ASENS	I		ACC power sense input
39	8VSENS	I		8V sense input
40	VDD			Power supply
41	X2			Crystal oscillator connection pin
42	X1			Crystal oscillator connection pin
43	IC			Connect to GND
44	XT2			Not used
45	XT1			Connect to GND
46	AVSS	I		A/D GND
47	SL	I		Tuner SD level detector input
48	K7MUTE	O		Mute control output for cassette
49	CDMUTE	O		Mute control output for CD
50	PDI	I		Data input from PLL IC
51	RDSRDY	I		Ready input from RDS IC
52	SD	I		SD input
53	TESTIN	I		Test program mode input
54	TELMUT	I		Telephone mute signal input
55	AVDD			Positive power supply terminal for analog circuit
56	AVREF	I		Reference voltage
57	RSDTI	I		Serial data input for RDS IC
58	RSDTO	O		Serial data output for RDS IC
59	RDCK	I/O	C	Serial clock output for RDS IC
60	PDO	O	C	Data output for PLL IC

Pin No.	Pin Name	I/O	Format	Function and Operation
61	PCK	O	C	Serial clock output for PLL IC
62	BSI	I		Communication data input
63	BSO	O	C	Communication data output
64	B \overline{SCK}	I/O	C	Communication serial clock input/output

*PE5157A

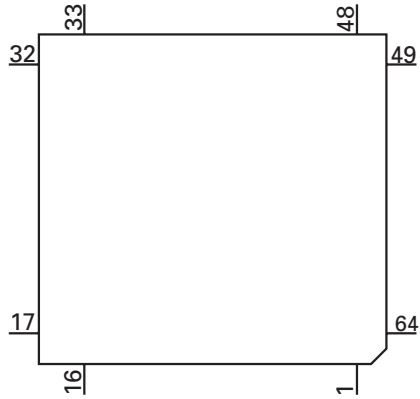

Output Format	Meaning
C	C MOS output

IC's marked by* are MOS type.

Be careful in handling them because they are very liable to be damaged by electrostatic induction.

CWV1065

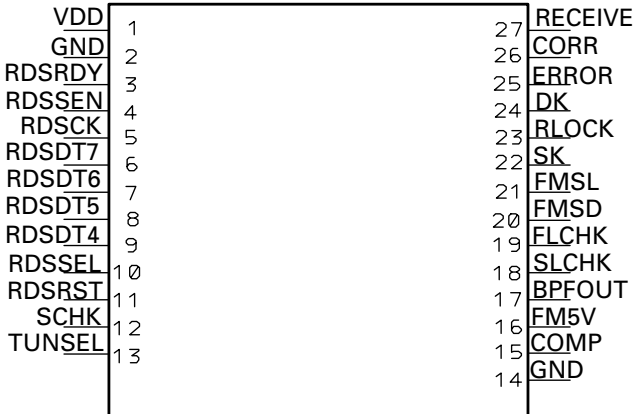

7.3 OPERATIONAL FLOW CHART

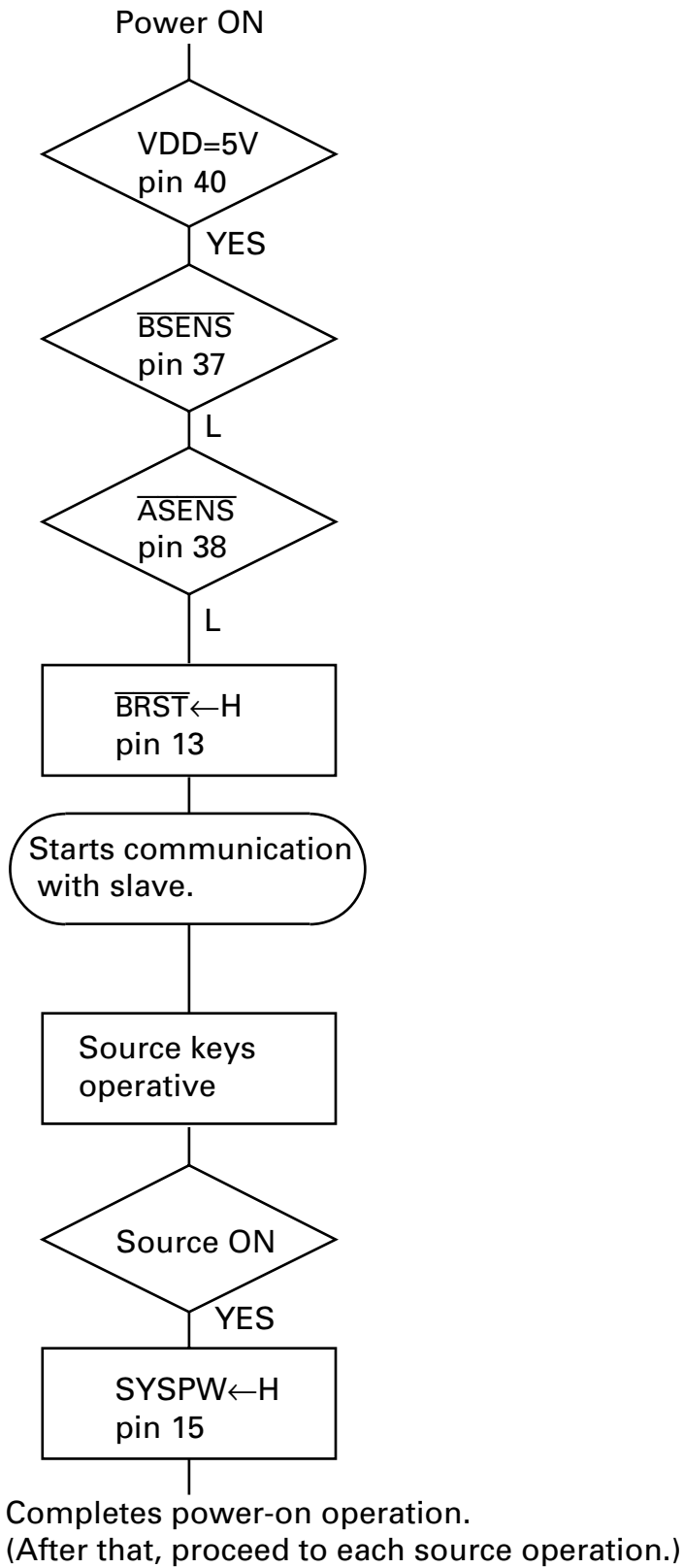

8. SPECIFICATIONS

General

Power source 14.4 V DC (10.5 – 16.0 V allowable)
 Grounding system Negative type
 Weight 1.1 kg

Amplifier

Maximum power output (SCU-2456ZRN) 15 W
 (SCU-2556ZRN) 40 W
 Rated power output (SCU-2456ZRN)..... 10 W
 (SCU-2556ZRN) 15 W
 Load impedance 4 Ω (4 – 8 Ω allowable)

FM tuner

Frequency range 87.5 – 108 MHz
 Usable sensitivity 10 dBf
 (1.0 μV/75 Ω, mono, S/N: 30 dB)
 40 dB quieting sensitivity 13 dBf
 (1.7 μV/75 Ω, mono)
 Signal-to-noise ratio More than 50 dB
 Distortion Less than 1.5%
 Stereo separation More than 20 dB

MW tuner

Frequency range 531 – 1,602 kHz (9 kHz)
 Usable sensitivity 29dBμ (S/N: 20 dB)
 Selectivity More than 45 dB

LW tuner

Frequency range 153 – 281 kHz
 Usable sensitivity 33dBμ (S/N: 20 dB)
 Selectivity More than 45 dB

Note:

- Specifications and the design are subject to possible modification without notice due to improvements.